

SATATYA VMSP Server

Quick Start

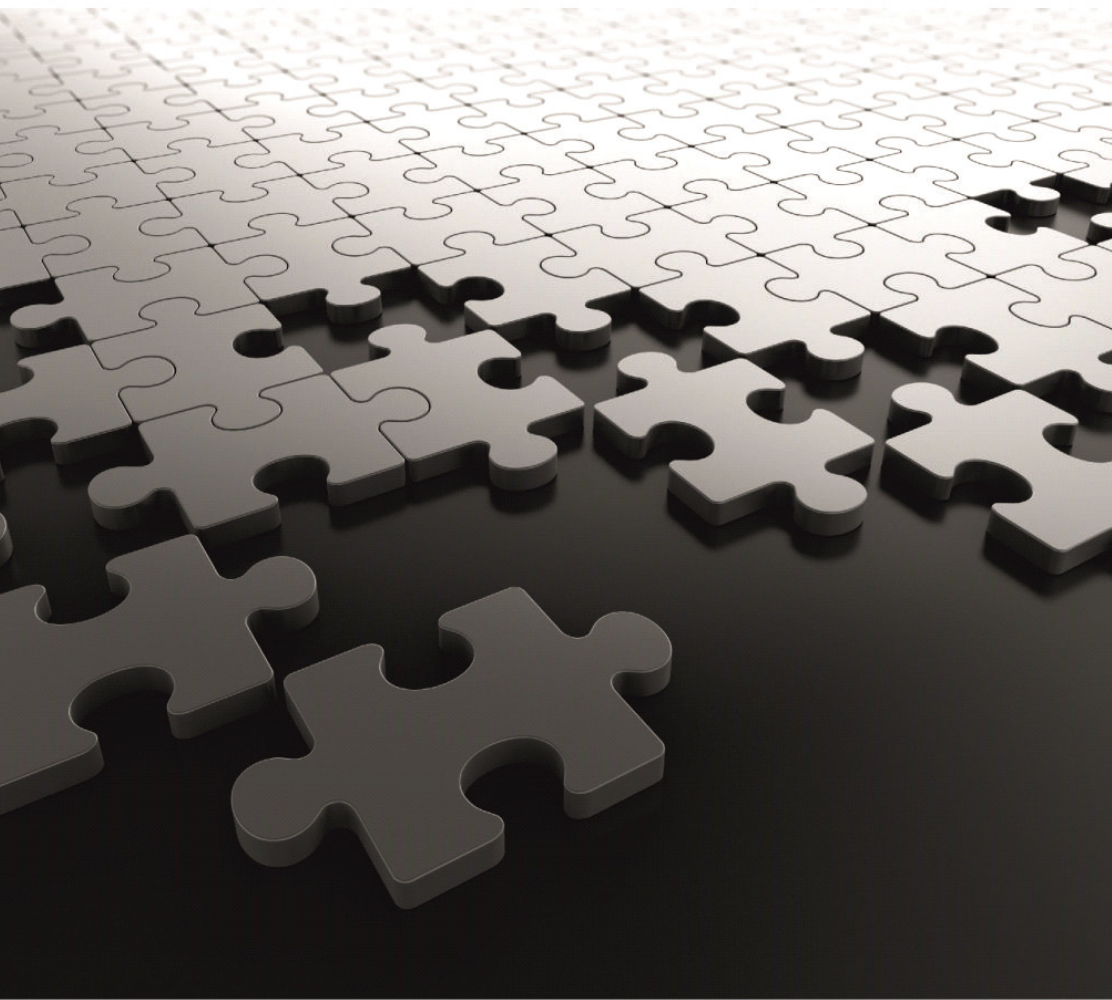

Matrix SATATYA VMSP Server

Video Surveillance Solution

Quick Start



Documentation Disclaimer

Matrix Comsec reserves the right to change, at any time, without prior notice, the product design, specifications, components, as engineering and manufacturing may warrant.

This is a general documentation for all models of the product. The product may not support some of the features and facilities described in the documentation.

Information in this documentation may change from time to time. Matrix Comsec reserves the right to revise information in this publication for any reason without prior notice. Matrix Comsec makes no warranties with respect to this documentation and disclaims any implied warranties. While every precaution has been taken in the preparation of this quick start, Matrix Comsec assumes no responsibility for errors or omissions. Neither is any liability assumed for damages resulting from the use of the information contained herein.

Neither Matrix Comsec nor its affiliates shall be liable to the purchaser of this product or third parties for damages, losses, costs or expenses incurred by the buyer or third parties as a result of: accident, misuse or abuse of this product or unauthorized modifications, repairs or alterations to this product or failure to strictly comply with Matrix Comsec's operating and maintenance instructions.

Warranty

For product registration and warranty related details visit us at:

<https://www.matrixcomsec.com/warranty/#IP-video-surveillance>

Copyright

All rights reserved. No part of this quick start may be copied or reproduced in any form or by any means without the prior written consent of Matrix Comsec.

Version 1

Release date: October 3, 2024

Contents

Introduction	1
Know Your VMSP Server	3
<i>The User Interface</i>	<i>8</i>
<i>Technical Specifications</i>	<i>9</i>
<i>Application of VMSP Server</i>	<i>14</i>
Installing VMSP Server	15
<i>Package Contents</i>	<i>15</i>
<i>Things You Will Need</i>	<i>15</i>
<i>Safety Instructions</i>	<i>16</i>
<i>Recommendations</i>	<i>17</i>
<i>Hardware Installation of VMSP Server</i>	<i>18</i>
Connecting VMSP Server	25
<i>Software Installation of the VMSP Server</i>	<i>28</i>
<i>Setting-up the VMSP Server using the Manager Utilities</i>	<i>51</i>
Configuring the VMSP Server	70
Appendix	79
<i>Disposal of Products/Components after End-Of-Life</i>	<i>79</i>

Introduction

Thank you for choosing the Matrix SATATYA VMSP, the video surveillance recorder.

This Quick Start is meant to help you get familiar with SATATYA VMSP, install the device and configure its basic parameters.

This is a common document for all the configurations of SATATYA VMSP Server. The terms Matrix SATATYA VMSP and Enterprise Network video recorder are used interchangeably.

If you have any concerns regarding the installation procedure, consult the Matrix Customer Care.

To view or download the documents related to this product, scan the QR Code printed on the Product Label/Packaging Label.

You may also view or download the documents from <https://www.matrixcomsec.com/support/ipvs-product-manuals/>

For product registration and warranty related details, please visit:
<https://www.matrixcomsec.com/warranty/#IP-video-surveillance>

Notices

The following symbols have been used for notices to draw your attention to important points.



Important: to indicate something that requires your special attention or to remind you of something you might need to do when you are using the system.



Caution: to indicate an action or condition that is likely to result in malfunction or damage to the system or your property.



Warning: to indicate a hazard or an action that will cause damage to the system and/or cause bodily harm to the user.



Tip: to indicate a helpful hint giving you an alternative way to operate the system or carry out a procedure, or use a feature more efficiently.

Know Your VMSP Server

In today's era, the technological need of organizations are no longer similar. The business solutions required by a Small Medium Enterprise are different from that of a Large Enterprise. So, most of the modern organizations want to invest in an economical business solution that accomplishes their specific technological needs.

Keeping in mind, the aspect of enterprise functionalities as well as the technological need of each and every organization, we offer the Matrix SATATYA VMSP Server.

Matrix offers VMSP Server as Integrated Hardware and Software Solution. It consists of SATATYA SAMAS Application ported on the VMSP Server. This perfect combination of a software application with a hardware platform, fulfills the business need of almost all the modern organizations.

Built on a high performance Xeon processors, video compression technology along with dual redundant Power Supply, as well as inbuilt GPU and Hardware RAID Controller, the VMSP provides uninterrupted performance while recording, monitoring and playback, best image quality with minimum storage space requirement. The solution supports Raid 0, 1, 5 and 10 functionality.

The Matrix SATATYA SAMAS is a sophisticated video management solution designed for large enterprises with multi-site surveillance requirements. This suite of applications provides comprehensive management and support for large number of cameras and other video surveillance devices, with centralized monitoring and control. The solution offers centralized management of Management Server, Recording Server, Admin Client, Media Client (Smart Client), Media Player (Backup Player), SATATYA devices and Cameras in a distributed network.

VMSP series uses Microsoft Windows10 IoT Enterprise LTSC Version as an Operating System. Hence this Server cannot be used as a general purpose application other than as VMSP Server. The Operating System must only be used in combination with VMSP Server. The Terms and Conditions for the use of Microsoft Windows Operating System are regulated by Microsoft's End User License Agreement. Matrix assumes that these Terms and Condition are acceptable to the End User.

VMSP Server

8 Bay Variant

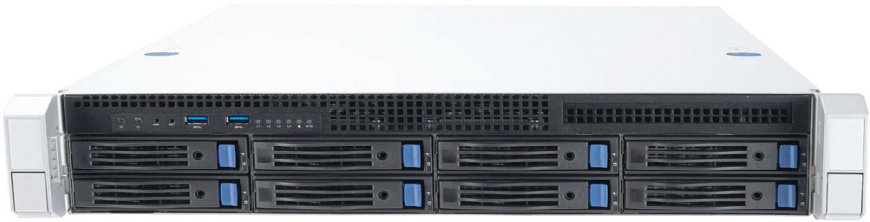

SATATYA VMSP2020XCTP: VMSP having configuration of SATATYA SAMAS Platform License (Default Licenses: 5 Camera License, 1 Concurrent User License, 1 ANPR, 1 CREAM, 1 EIVA, 5 VTPM, Matrix Access Control Integration and Multi-display) and expandable upto 255 IP channels using SATATYA SAMAS Software Camera License having 8 hard disks.

VMSP Panels

You can view the details of the panel below:

VMSP2020XCTP

Front View - VMSP2020XCTP



Front Controls and Indicators

8 Hot-Swap HDD Trays

Front Controls and Indicators - VMSP2020XCTP

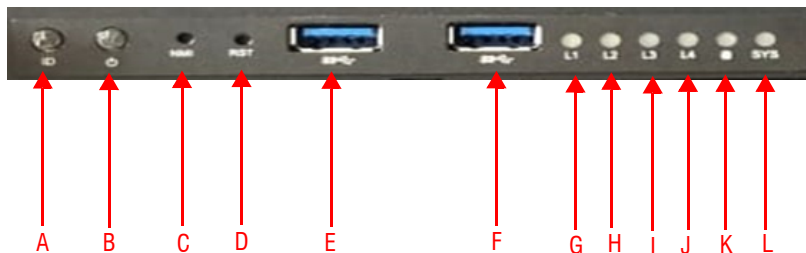

Sr.No.	Interface	Description
A	ID Switch	Press the button to activate system identification.
B	Power Switch	Press button for system power on.
C	NMI Button	Push the button to activate user-defined function.
D	Reset Button	Push the button to activate system reset.
E	USB 3.0	USB 3.0, used for Scheduled and Manual Backup. To connect USB Mouse. To connect Dongle.
F	USB 3.0	USB 3.0, used for Scheduled and Manual Backup. To connect USB Mouse. To connect Dongle.
G	LAN1 LED	Blinks when internet is busy
H	LAN2 LED	Blinks when internet is busy
I	LAN3 LED	Blinks when internet is busy
J	LAN4 LED	Blinks when internet is busy
K	HDD Activity LED	Blinks when HDD is busy
L	Failure LED	Blinks when there is a failure

Rear View - VMSP2020XCTP

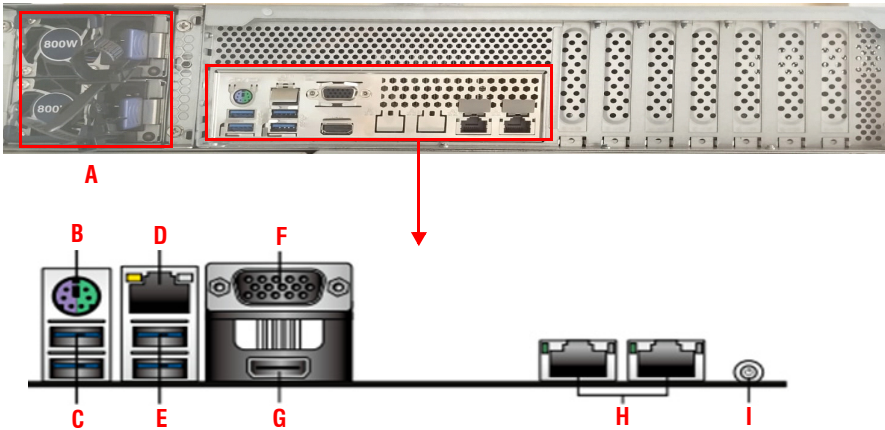

Label	Interface	Description
A	Power Supply	Redundant Power Supply (1 + 1) of 800W
B	PS/2 Keyboard/Mouse Port	To connect Keyboard/Mouse
C	USB 3.2 Gen1 Port 5	To connect USB Mouse/Keyboard.
	USB 3.2 Gen1 Port 6	To connect Dongle /Hard Disk for Eternal Storage
D	1G LAN RJ45 Port	To connect Ethernet cable to the port of the Server (IPMI-Management Port).
E	USB 3.2 Gen1 Port 3	To connect USB Mouse/Keyboard.
	USB 3.2 Gen1 Port 4	To connect Dongle /Hard Disk for Eternal Storage
F	VGA Port	To connect a VGA compatible Monitor.
G	Display Connectors	HDMI 2.0b
H	10G RJ45 Port 1	To connect Ethernet cable to the port of the Server.
	10G RJ45 Port 2	To connect Ethernet cable to the port of the Server.
I	Power On Button	Press to turn on the system.

General Specifications

Parameters	Description
Power Supply	100 to 240 VAC, 10-5A at 50/60 Hz - Dual Input 800W Hot Swap Redundant Power Supply (1 + 1)
Operating Temperature	10°C ~ 50°C
Non-operating Temperature	-40°C to 70°C
Humidity	20% to 90% RH Non-Condensing

The User Interface

The SATATYA SAMAS Application provided various user interfaces which servers different user requirements:

SATATYA SAMAS Admin Client

The SATATYA Admin Client enables you to configure — Users, Servers, Access Control, Features etc offered by the Matrix SATATYA SAMAS.

To know more, refer to the ***SATATYA SAMAS Administrator Guide***.

This guide is available in the Software itself. On the Home page of the Admin Client, click

Settings  and then select **Help**.

SATATYA SAMAS Smart Client

The SATATYA Smart Client enables access to live and stored video images of VMSP Server from a remote location through the Web. Using the Smart Client you can access, search, browse, display and transfer stored video to a remotely connected workstation. You can configure the VMSP Server and camera settings, receive notification of events such as alarm, motion detection and video loss.

To know more, refer to the ***SATATYA SAMAS Smart Client Manual***.

This guide is available in the Software itself. On the Home page of the Smart Client, click

Settings  and then select **Help**.

SATATYA SAMAS Vision

SATATYA Vision is a mobile application which supports live view of the channels and allows the user to view the live recordings any time, anywhere, on your smart devices. SATATYA Vision supports Android and iOS-based devices.

To know more, refer to the FAQs *for Android and iOS* respectively in their respective software.

Technical Specifications

SATATYA VMSP2020XCTP

HARDWARE	
Processor - CPU	Intel Xeon processor E-2356G @ 3.2 GHz
Memory	32GB DDR4
OS Drive	Enterprise-grade M.2 SSD 240GB
SATA 3.0 Channels	8 Bay
Storage Capacity	Max 144TB (support upto 18TB each HDD)
PCIe Type	- 2 PCIe3.0 x8 - 1 PCIe4.0 x8 - 1 PCIe4.0 x16
Video Display	- 1x HDMI on board
Chassis	2U chassis with 12G
Hot Swap HDD Bays	8 SATA HDD/ SSD 3.5" or 2.5"
Graphics	A speed AST2600 with 64MB VRAM
RAID Controller (inbuilt)	LSI-9361-8i 12G SAS 1GB (Hardware RAID)
RAID Support*	RAID 0/1/5/6/10/50/60
NETWORK MANAGEMENT , INTERFACES & SECURITY	
Network	2x 10GbE RJ45
Sensor In/ Alarm Out	Yes Through Sensor Controller Panel Lite device
Audio In/ Out	No In built
USB	- 4x USB3.2 rear - 2x USB3.0 front - 1x USB3.2 onboard - 1 x USB3.2 Gen1 (header, 2 ports) - 1 x USB2.0 (header, 2 ports)
Security	TPM header support
ELECTRICAL	
Input Voltage	100 to 240 VAC, 10-5A at 50/60 Hz - Dual Input
Power Supply System	1+1 800W hot swap RPS

Power Consumption	To be Calculated*
MECHANICAL	
Dimension (D x W x H)	625 x 482.6 x 87mm (24" x 19" x 3.5")
Material	SGCC
Nett Weight	12.8 KG
ENVIRONMENTAL	
Operating Temperature	- Operation temperature: 10°C ~ 50°C - Non operation temperature: -40°C ~ 70°C
Relative Humidity	Non operation humidity: 20% ~ 90% (Non condensing)
CERTIFICATION	
CE; FCC; BIS	Work In-Progress
SOFTWARE	
Operating System	Microsoft Windows 10 IoT Enterprise LTSC HIGH END
Event Database	Microsoft SQL Server Express Edition (upto 10 GB of Storage)
Software	Video Management Solution - SATATYA SAMAS
VIDEO SURVEILLANCE MANAGEMENT	
IP Camera Channels	5 IP Channels (User can expand up to 255 IPC using SAMAS software Cam licenses)
Resolution Support	12MP, 8MP, 5MP, 3MP, 2MP, 720P, D1, CIF
Compression	H.265, H.264, MJPEG
Onvif Profile Support	Onvif S and G
IP Camera Supports	Matrix Brand, Third Party - Onvif Profile S and G Supported
Active Directory Support	Yes
User Roles and Rights	Yes
DISPLAY	
Split (Through LAN/HDMI)	1x1, 2x2, 3x3, 4x4, 5x5, 6x6, 8x8, 1+3, 1+5, 1+7 and Sequential Views and Windows Sequence
Local Decoding	1x 4K/ 4x 1080P/ 16 x D1 @H.264
Digital Zoom on Live	Yes
Snapshot	Yes

OSD	Channel Number and Name, Status, Video Loss, Recording and Disabled Channel (As per camera support)
RECORDING	
Pre-Record	Up to 30 Sec
Post-Record	Up to 30 Sec
Snapshot Format	JPG
Recording Format	Native
Recording Types	Continuous, Manual, Alarm and Motion Detection
Special Recording	Time Lapse Recording and Day-Highlights
Adaptive Recording	Automatically Reduces the Number of Frames Captured Per Second Where There is No Motion, Thereby Saving Storage Space
INTEGRATED PLATFORMs Over Network	
Redundant Service	Yes. Storage & Recording Services (N+1),
Failover Service	Yes. Recording Services (N+1) & Network ISP Service (1+1)
Matrix IVA Service	Yes (Basic & Advance IVAs, ANPR, Parking Management & More Over Ethernet)
Business Application	SAP, ERP and PoS
Access Control System	Yes. Matrix COSEC Server and COSEC PANEL200 for Aux I/O Integrations
Streaming Services	Yes. For Integrations with Third Party IVA and Investigation Agency
VMSP Clients	Desktop Client: SATATYA Smart Client, Video Wall Client Mobile Clients for Android and i-OS Devices
PLAYBACK & BACKUP	
Synchronous Playback	16 channels @ 1080P (via Ethernet)
Search Mode	Date, Camera, Recording Type
Playback Modes	Fast Forward, Fast Reverse at Different Speed Control,
Backup & Archive	3 Levels, Video Grooming Technology
Network Protocol	TCP/IP, DHCP, FTP, SMTP, RTP/RTSP, CIFS/NFS, UDP, LDAP
Maximum User	99+1
Remote Operation	Monitor, PTZ Control, Playback, System Setting, File Download, Log Information,

PERCEPTIVE MONITORING FEATURES	
Hierarchical E-map	Yes
Alarm Management	Yes (Report, Acknowledge, Close & Alarm Logs)
System Health Dashboard	Yes
Investigator	Video Content Analysis on Recorded Video (Over Ethernet)
One Click Control	IPC view, Recording Status, Health, Snapshot, Manual Recording
On Screen PTZ Control	Yes using Virtual PTZ Joystick
SURVEILLANCE LOGS	
Logs	Event Logs, Audit Trails, Alarm Logs and Online User information
Reports	Summary Report, Downtime Analysis Report, Evidence Reports, System Health Reports
Report Scheduler	Yes (Daily, Weekly, Monthly)
EVENTS & ACTIONS	
EVENTS	Video Surveillance Events, System Events, User Events, Audit Trails Events
ACTION	Recording on Selected Channel, Upload Images on FTP/Email server, Email Notification with Snapshot, Trigger IVA, Recall PTZ Preset Position, Turn On/Off Alarm Outputs, Buzzer Notification, SMS Notification, Calling from Mobile App, Share files data, Trigger Aux Output
SYSTEM SETUP	
LED Indication	System Power; Ethernet Connection, SATA Connectivity
Power On & Reset Switch	Yes
For More Information on Software Part	Please refer to the VMS SAMAS Datasheet.

Important Notice	<p>This Product uses "Microsoft Windows 10 IoT Enterprise Version" as an Operating System. So, the server can not be used as a General Purpose application other than E-NVR/VMSP Server. The included Microsoft Windows Operating System must only be used together with the Product (E-NVR/VMSP Server) and must hence not be used on any other computer hardware. The terms and conditions for the use of the Microsoft Windows Operating System is regulated by Microsoft's End User License Agreement and it is accepted to the End User ("Customer purchasing the E-NVR/VMSP Product").</p>
*	*Work and Validation in Progress

Application of VMSP Server

SATATYA VMSP2020XCTP

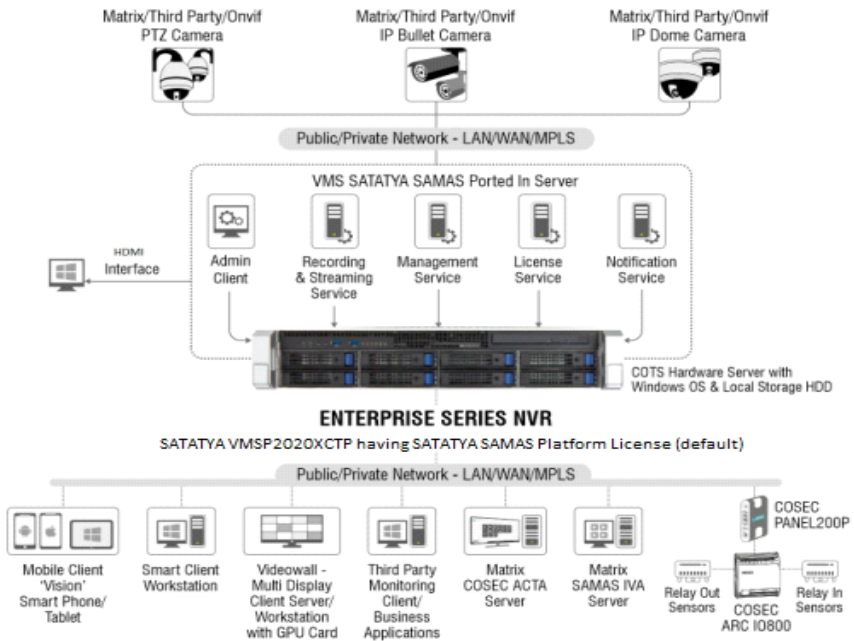

Installing VMSP Server

Package Contents

SATATYA VMSP2020XCTP

- 2 qty 250V-10A Power Cable
- 2 qty Sliding Rails for Rack installation
- 2 qty Jumper for HDD Board Panel
- 1 qty Number Strip
- 3.5" HDD screws
- 2.5" HDD internal screws
- 2.5" HDD screws
- Cable tie for system
- Mother Board Screws

Things You Will Need

- A Power Hand Drill
- A Wire Stripper
- Insulation Tape
- A Screwdriver set
- Device (IP Cameras, NVR).
- Monitors with the appropriate cables to connect.
- At least one SATA Hard Disk (upto 18TB), if you want to record on a hard disk in the SATATYA VMSP Server. You can install 8 hard disks.
- A USB Mouse or Keyboard (Wired or Wireless) to operate the SATATYA VMSP Server.
- A personal computer or a LAN computer to access the Admin Client or the Smart Client.
- An Ethernet cable to connect to a computer/LAN/WAN (over a DSL Modem or Router).
- A rack to mount the SATATYA VMSP Server in a rack.

Safety Instructions

- The Matrix device is intended for indoor use and can only be Rack Mounted. Equipment must thus be installed into a controlled, dry, clean and secure environment where temperature and humidity are within product specifications.
- Examine site conditions prior to installation. Notify the person concerned if unsuitable conditions are encountered. Do not start installation until site conditions are acceptable.
- Use the power cord which is supplied along with the equipment. The product should be operated with appropriate power voltage supply as mentioned in the specification sheet. Ensure adequate earthing at the installation site.
- Do not touch the product with wet hands. Equipment must be installed by a trained professional.
- Prevent metallic, foreign or liquid substances from getting inside the product. This includes insecticide or flammable cleaning spray.
- Make sure in the Rack there is minimum 1-2 inches air gap between two systems (bottom and top). Vent holes are provided in the system for air ventilation, make sure there is no obstruction to block it.
- Make sure the operating temperature for the systems is between 10°C to 50°C day and night.
- Ensure appropriate mains filtering and UPS are used in areas where the power source is susceptible. Damage through power source fluctuations, spikes, etc. is not covered by warranty.
- Do not cut off the power or move the unit when hard drives are operating. Doing so may cause damage and loss of data.
- Make sure you have complete the wiring and installation of all the devices you want to connect to VMSP Server.

VMSP Server will be provided with the following Services and Clients:

- Management Server
- License Server
- Recording Server
- Notification Server
- Transcoding Server
- ONVIF Server
- IVA Server
- Admin Client
- Smart Client

The following Devices, Services and Clients are supported by VMSP Server and can be installed/connected as per your requirement:

- Smart Client in multi-monitor mode (needs to be installed in a separate Server)
- NVRs, DVRs and IP Cameras
- COSEC CENTRA Server
- COSEC PANEL200
- ARC IO 800 Controller
- Smart Client (needs to be installed in a separate Server)
- Media Player (needs to be installed in a separate Server)
- Third Party / Business Application for Integration

Further the Installation and Connecting instructions have been divided into the following sections:

- Hardware Installations, refer "[Hardware Installation of VMSP Server](#)".
- Connecting, refer "[Connecting VMSP Server](#)".
- Software Installations, refer "[Software Installation of the VMSP Server](#)".

Recommendations

- Make sure you configure recording of maximum 64 channels in each HDD. If multiple HDD's are installed make sure you distribute the recordings.

For example, if you have installed 8 HDD's and 256 camera's, then in each HDD recording of 32 camera's can be configured.

- Make sure both the Power Supplies are connected. If one Power Supply is connected it will result in degraded performance and a buzzing sound may occur.
- The workstation requirement will vary if you want to run a configuration other than the one specified under Technical Specifications > Display > Local Decoding and Playback and Backup > Synchronous Playback. For details, refer to "[Technical Specifications](#)".

Hardware Installation of VMSP Server

- Unpack your VMSP Server and check the package contents.

For details, refer to [“Package Contents”](#).

Do not discard the packaging material. If any of the items is missing or damaged, please contact the source from where you purchased the product.

- You are recommended to first install the hard disk(s) and make the required cable connections. Refer to [“Opening the Top Cover”](#) and [“Installing the Hard Disk”](#).
- For Rack mounting, refer to [“Rack Mounting”](#) instructions.

Opening the Top Cover

- Always wear an electrostatic discharge preventive wrist strap or belt and use a grounding mat.
- Make sure the power supply is disconnected. Unplug the power cable, if you have connected it to your VMSP Server.
- Make sure the thumb finger touches downward, and then push back the rear back cover.
- Check and release the screws from the sides.

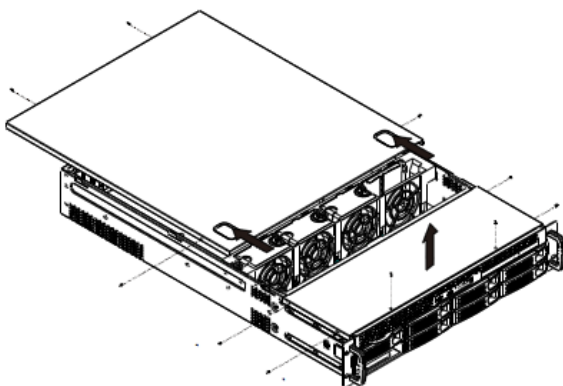

- Place your hand on the front top cover and pull it out.

Installing the Hard Disk

VMSP Server support maximum 8 Hard disks. Each hard-drive can support upto 18 Terabytes. By default, no Hard disk is provided with the system. You can install them as per your requirement.

You are recommended to install video surveillance SATA Hard disks of any standard brand.



Any electrostatic energy coming in contact with the hard disk or the internal parts of the VMSP Server can cause permanent damage to them. Before you begin the installation of the hard disk, make sure your workstation is static-free. Always wear an electrostatic discharge preventive wrist strap or belt and use a grounding mat.

- Insert the hard drive on the tray.
- Use four screws to fix the HDD.
- Slide the tray into the HDD bay.

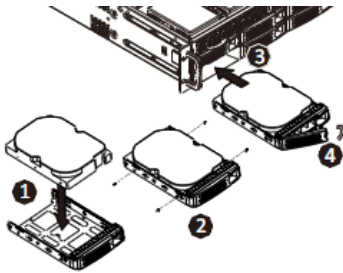

- Push the lever to latch HDD tray.



Maximum torque to be applied for tightening the screws is 3 kgf.cm. Applying more than specified torque will cause a damage to the HDD and the emboss.

Rack Mounting

There are two rails — inner rail and outer rail. You can install the rails into the racks using the round holes or square holes.

Follow the instructions given below:

- Release and detach the inner rail from the outer rail.

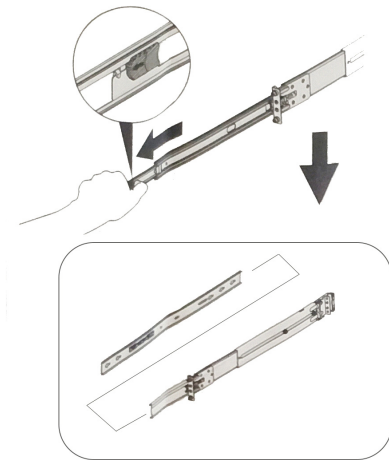

- Align the inner rail with the system.

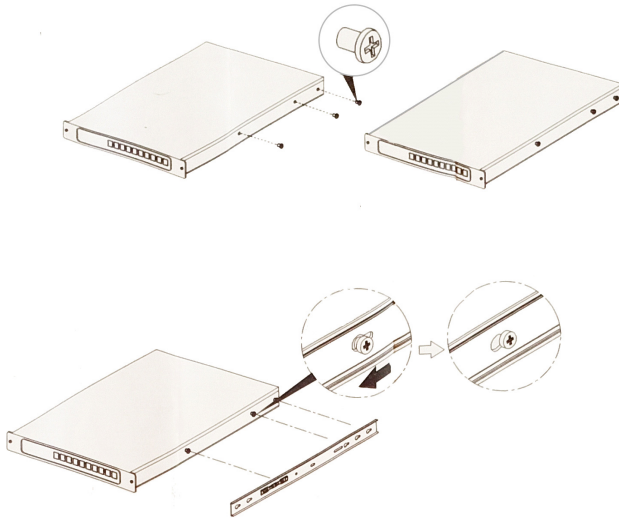

- Fasten it with the P-head to make sure it is well locked and the inner rail does not loosen from the system.

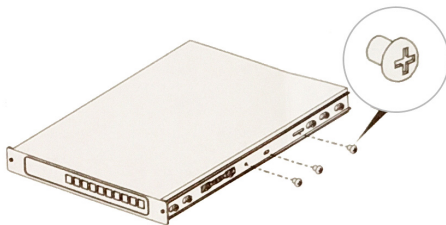

- Attach the outer rail to the rack.

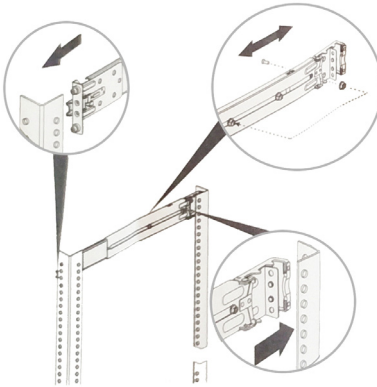

- Make sure the bearing retailer in locked forward. Horizontally install the system half way into the slide rail.

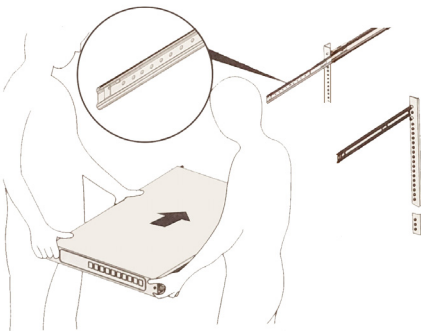

- Slide the release tab on the side and push system into the rack.

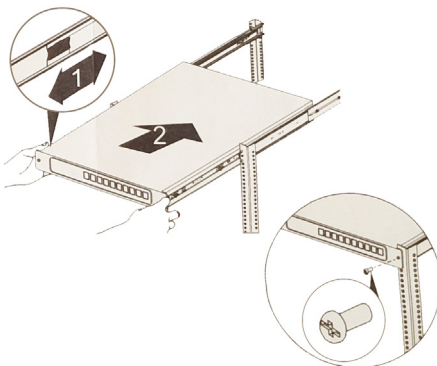

- You can use Round Hole pins or Square hole pins. Align the holes of the system with those of the rack and insert the screws. Tighten them to fix the system in place.

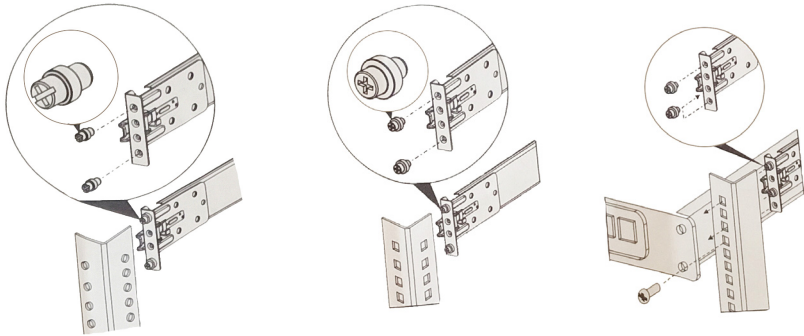

Connecting VMSP Server

Connecting Devices

Cameras

VMSP Server	Number of IP Cameras supported (default)	Number of HDD supported
SATATYA VMSP2020XCTP	5	8

Make sure the camera's are installed as per your requirement.

Server

The provided Server does not have any default IP Address. Contact your Network Administrator and configure the same. The Default User Name is **admin** and Password is **1234**.

Monitors

- You can connect a HDMI compatible Monitor to the HDMI Ports.
- Connect one end of the cable to the Video IN of the monitor and the connect the other end to the HDMI port.



The recommended length of the cable is upto 3 meters (9.8 ft.).

LAN/WAN

You can connect VMSP Variants to a LAN switch or to a WAN.

- Connect the Ethernet cable from your computer/LAN Switch to the LAN Port on the Rear panel.
- To connect the Server to the Internet, connect its LAN port either directly to the DSL Modem or Router or over a LAN Switch.



When connecting the LAN Port of the Server to a network computer, you may need to change the IP Address, the Subnet Mask and Gateway address of the Server. You may ask your Network Administrator for the IP Address assignment used on the network, the IP Address, Subnet Mask and Gateway Address for the Server, refer “[Changing the IP Address \(Windows10\)](#)”.

Backup Storage Device

To store back up of the recordings, you may connect any removable storage device such as an external hard disk to the USB Ports.

Mouse/Keyboard





- You can connect a wired or wireless Mouse or Keyboard to the USB port.

Connecting Power Supply

- Connect one end of the Power cable into the Power Supply on the Server and the other end into the power outlet. Make sure the port is a Dual Input port as two Power Supply's need to be connected.
- Switch on power supply. Wait for the reset cycle to complete.

Changing the IP Address (Windows10)

To change the IP Settings, follow the steps given below:

- Select **Start** , then select **Settings**  > **Network & Internet** .
- Select **Ethernet** , then select Ethernet Network you are connected to.
- Right-click on the selected Ethernet Network and click **Properties**.
- Under **Properties**, select **IP Network Version 4**.
- Click **Properties**, select **Automatic (DHCP)** or **Manual**.
 - To specify the IPv4 settings manually,
 - Under **Edit IP settings**, select **Manual**, then turn on **IPv4**.

- To specify the IP address, in the **IP Address**, **Subnet prefix length** and **Gateway** boxes, type the IP address settings.
- To specify the a DNS server address, in the **Preferred DNS** and **Alternate DNS** boxes, type the address of the primary and secondary DNS servers.
- When you select **Automatic (DHCP)**, the IP address settings and DNS server settings are set automatically by your router or other access point.
- When you select **Manual**, you can manually, set your IP address settings and DNS server address.
- Select **Save**.

Software Installation of the VMSP Server

Pre-requisites for RAID Installation

- VMSP Servers come pre-equipped with Hardware RAID Controller.
- Hard-drives added to an empty server need to be configured before they can be used for video recording.
- As and when the HDD is mounted in the drive successfully, the same will be indicated by Green LED on the respective Disk slot.
- As and when the HDD is mounted in the drive and if a Red LED glows on the respective Disk slot, it indicates that the HDD is faulty.
- The RAID configurations of new hard drive must be set-up manually via pre-installed RAID Management Application or BIOS.
- Only after the configurations are done the server will provide full functionality of RAID for storage.

The Software Installation of VMSP Server includes two steps:

- [“Installing and Configuring RAID”](#)
- [“Installing SATATYA SAMAS Components”](#)



Make sure you have the Administrator rights.

Installing and Configuring RAID

Follow the steps for installing and configuring RAID.

- Below is the image of the Hardware RAID controller.

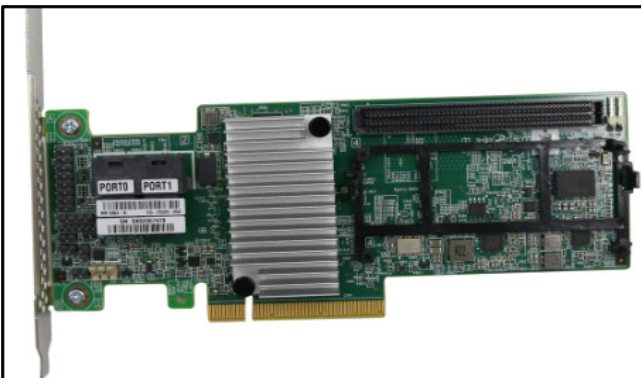

- Below is the image of the cable, using which you can connect the RAID controller to the expander backplane of the Server.



- Mount the RAID controller on the Server board as displayed in the image (Green color circuit board). Insert one end of the cable into the RAID controller and the other end into the Server backplane.

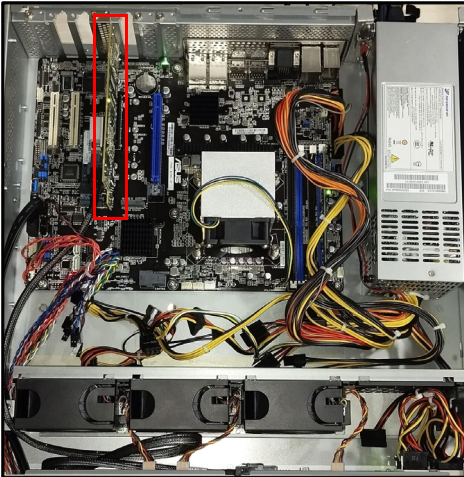

- After installing, open the software. It displays the Host, IP Address, OS. Click on the Host or IP Address.

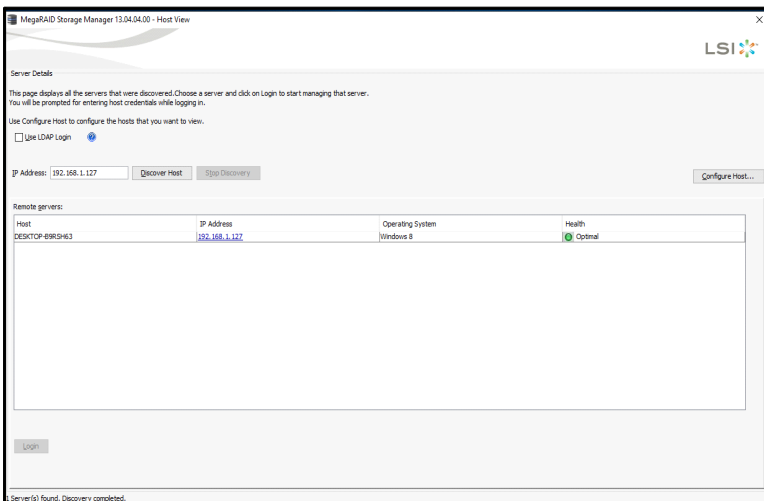

- A pop-up appears. Enter the **UserName** and **Password** (This is the windows UserName and Password you entered. Enter the same here.)

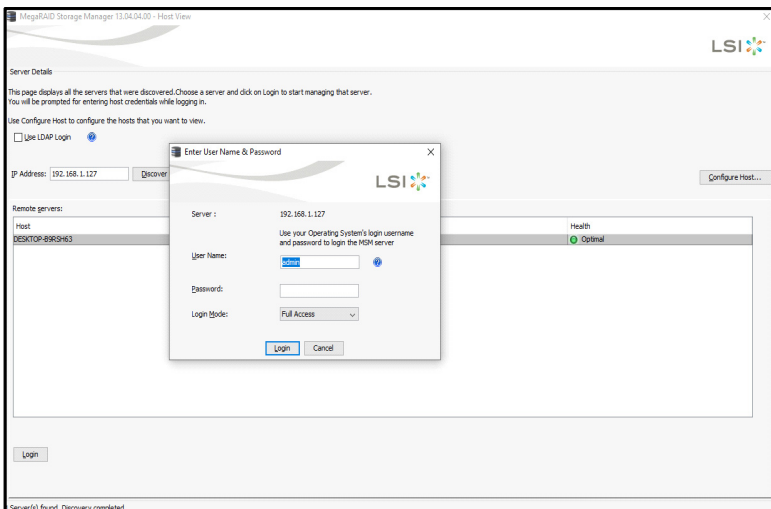

- Click **Login**.

- You will be directed to the Dashboard where you can view the connected drives, whether RAID is created or not, etc as well as the storage details.

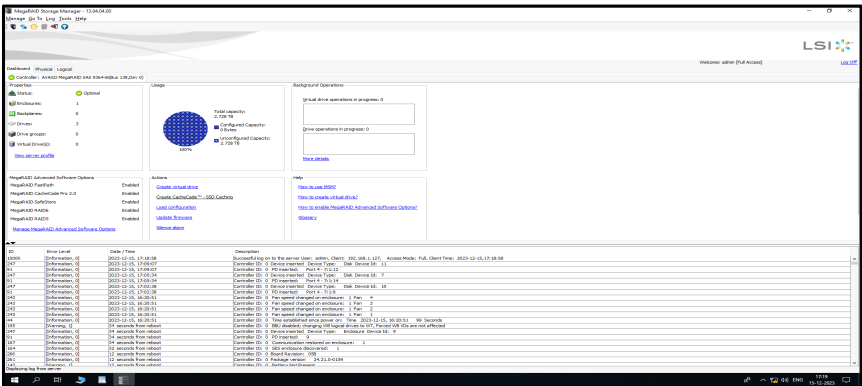

- Click **Create Virtual drives** and the following screen appears. Click **Simple** and then click **Next**.

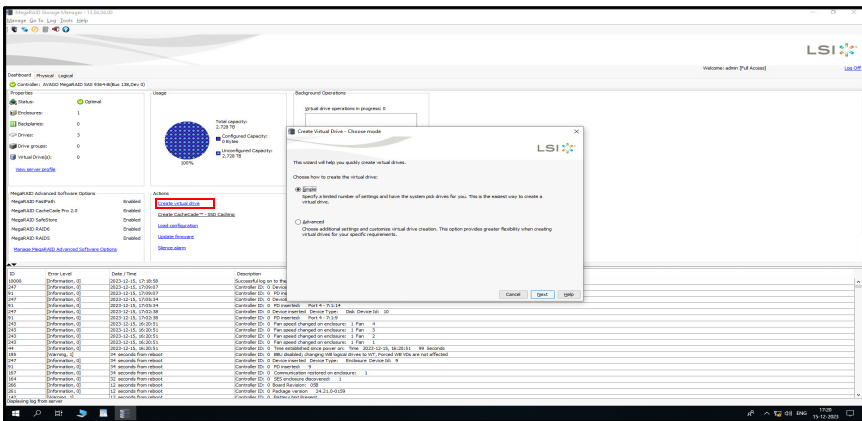

- Click **Finish**. The Virtual Drive will be created with the configured RAID.

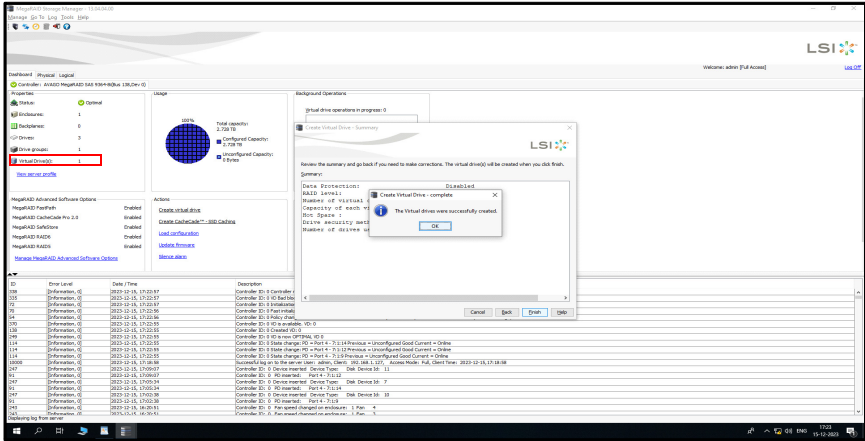

- Click the **Logical** tab. The created RAID is displayed.

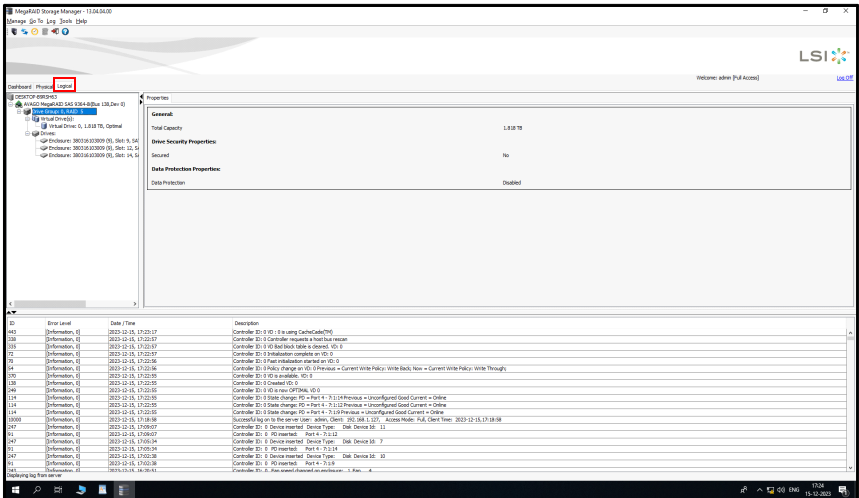

- The **Disk Management** pop-up appears.

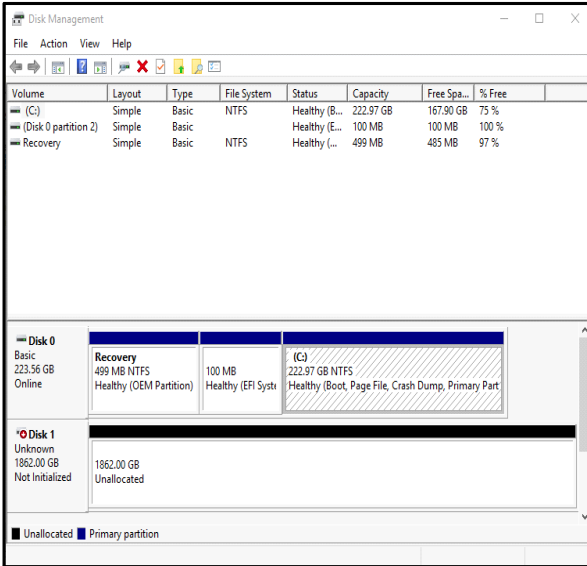

- The **Virtual Disk** pop-up appears. Select the **GPT (GUID Partition Table)** option.

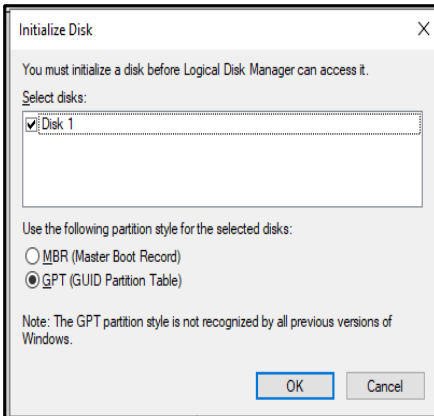

- Right-click on **Unallocated** and click the **New Simple Volume** option.

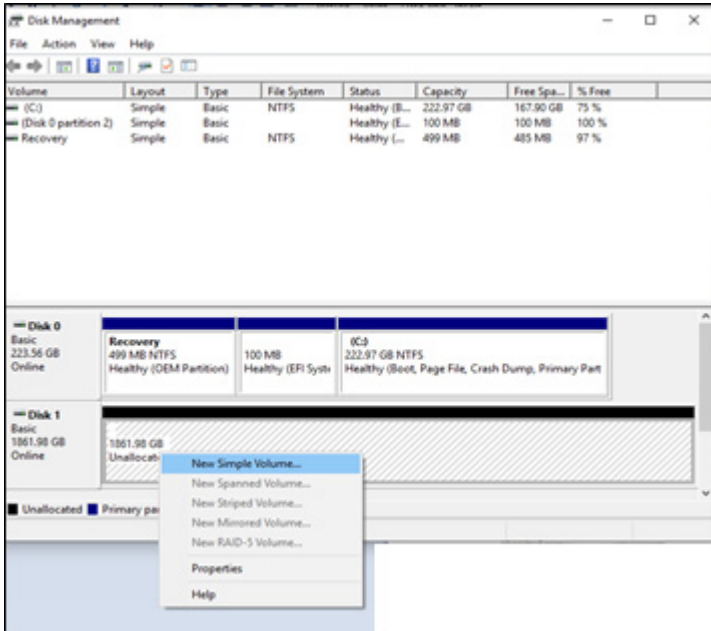

- The **New Simple Volume Wizard** opens.

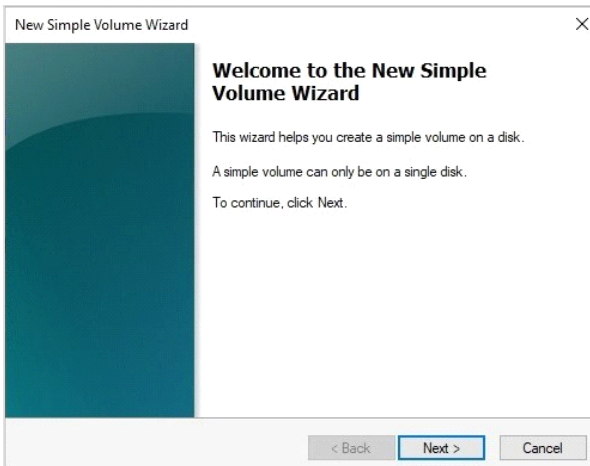

- Click **Next**.

- Under **Specify Volume Size**, keep the default values of the parameters.

The screenshot shows the 'New Simple Volume Wizard' dialog box with the 'Specify Volume Size' step selected. The title bar reads 'New Simple Volume Wizard' with a close button (X). The main heading is 'Specify Volume Size' with a subtitle 'Choose a volume size that is between the maximum and minimum sizes.' Below this, there are three rows of information: 'Maximum disk space in MB:' with the value '14498664', 'Minimum disk space in MB:' with the value '8', and 'Simple volume size in MB:' with a dropdown menu showing '14498664'. At the bottom, there are three buttons: '< Back', 'Next >', and 'Cancel'.

- Click **Next**.
- Under **Assign Drive Letter or Path**, in **Assign the following drive letter**, select the desired letter from the drop-down list.

The screenshot shows the 'New Simple Volume Wizard' dialog box with the 'Assign Drive Letter or Path' step selected. The title bar reads 'New Simple Volume Wizard' with a close button (X). The main heading is 'Assign Drive Letter or Path' with a subtitle 'For easier access, you can assign a drive letter or drive path to your partition.' Below this, there are three radio button options: 'Assign the following drive letter:' (which is selected), 'Mount in the following empty NTFS folder:' (with an empty text box), and 'Do not assign a drive letter or drive path'. A dropdown menu is open, showing a list of drive letters from 'D' to 'Z', with 'D' selected. At the bottom, there are three buttons: '< Back', 'Next >', and 'Cancel'.

- Click **Next**.
- Under **Format Partition**, select the option **Format the volume with the following settings**. In **Volume Label**, configure the name you wish to assign to the Volume.

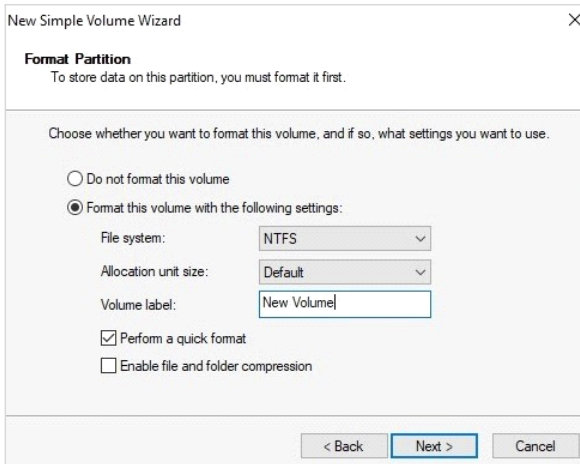

- Click **Next**.

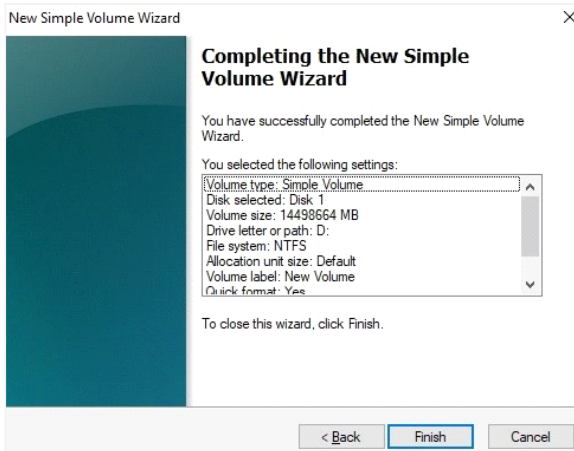

- To complete, click **Finish**.
- Click My PC/Computer this new volume appears as a new drive.

- The RAID will be deleted.

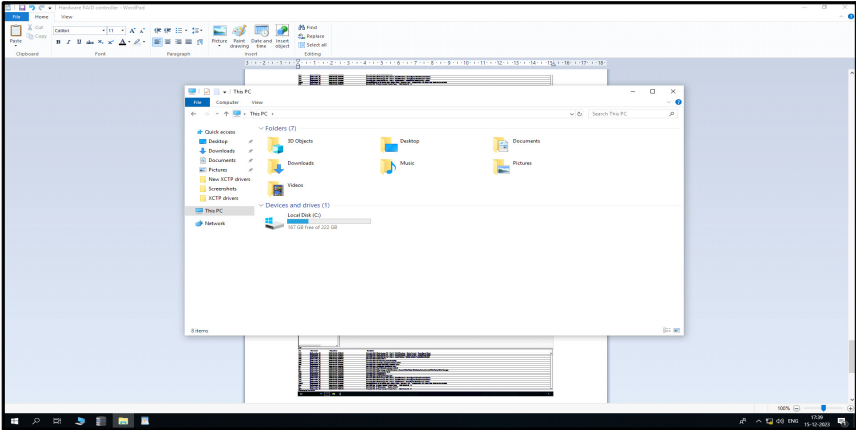

Now, you can proceed further with the installation of the SATATYA SAMAS components.

Installing SATATYA SAMAS Components

The following are already installed in the VMSP Server:

- Management Server
- License Server
- Recording Server
- Notification Server
- Transcoding Server
- ONVIF Server
- IVA Server
- Admin Client
- Smart Client

Create/Upgrade/Backup Database

The SATATYA SAMAS allows the user to create a new database and upgrade or take the backup of the existing one. Click on the links below for detailed information.

[“Creating/Upgrading Database”](#)

[“Database Backup”](#)

Creating/Upgrading Database

You can create and upgrade the SAMAS Database using Database (DB) Utility.

The DB Utility can be opened either by clicking on the **Click Here** link just after completion of the installation or click on your PC Search option and enter **Database Utility**. Click the same.



The SATATYA SAMAS Database Utility window appears.



Make sure you have MS SQL Server 2008 on which the SAMAS database can be created.

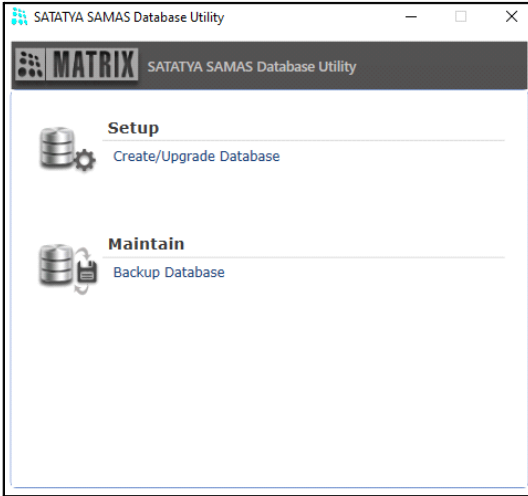

Click **Setup** to create or upgrade an existing database.

The database utility setup page appears as shown below. Click **Change Settings** and select the **New Database** check box. Specify the Database Connection Settings as described below.

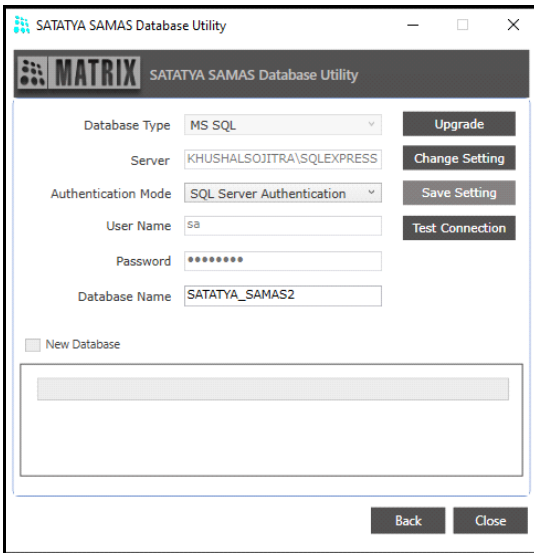

- **Database Type:** The database type supported is MS SQL Server.

- **Server:** Specify the database Server Name in the following format:- Database server name\Instance Name e.g. dbserver\sqlexpress.



The Server Name is the name/IP of the system where the MS SQL Server (DB Server) is installed.

- **Authentication Mode:** Select the desired option from the drop-down list— SQL Server Authentication or Windows Authentication.
- **User Name:** Specify the User Name of the user of SQL Server. By default, User Name is **sa**.
- **Password:** Enter the Password of the user of SQL Server. By default, Password is **Matrix@123**.



The password is case-sensitive. Make sure it is entered in the same format as mentioned above.

- **Database Name:** Specify the Database Name of the SAMAS application. By default the application creates a database by the name of “SATATYA_SAMAS”.

Click **Create** to start the creation of the database.

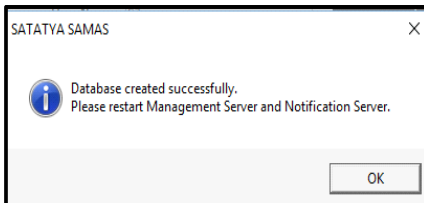

Click **Test Connection** to test the connection with the database server. The connection will be successful only if all the parameters have been configured correctly.

Save the settings once done by clicking **Save Setting**.

You can now start using the SAMAS applications installed on the computer.

Once the SAMAS database has been created using the above procedure, the administrator needs to subsequently only use the **Upgrade** option as and when required. Do not select **New Database**.

Click **Upgrade** to upgrade the database.

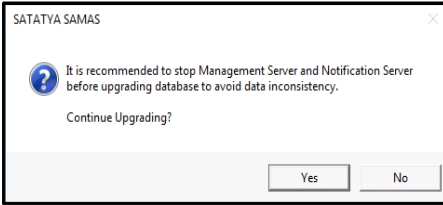

Database Backup

In the event of software or hardware problems, it is always a good idea to have a recent copy of your database files. The **Backup** option allows the administrator to take backup of the database at regular intervals. You can take the backup of the database using the Database Utility.

The Database Utility can be opened either by clicking on the **Click Here** link just after completion of the installation or click on your PC Search option and enter **Database Utility**. Click the same.

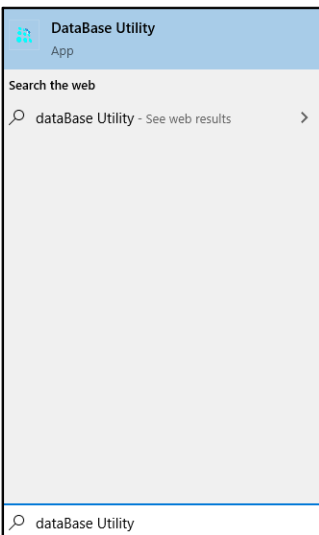

The SATATYA SAMAS Database Utility window appears.

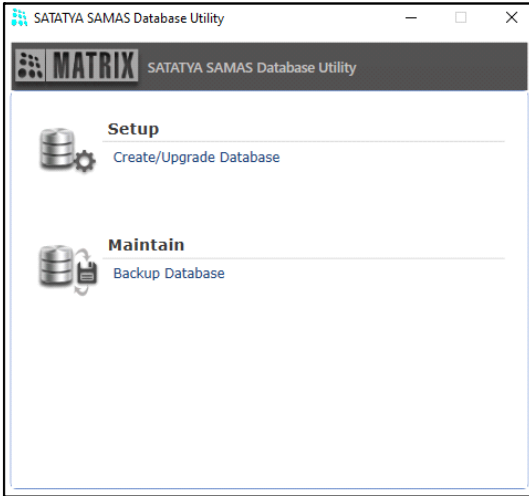

Click **Maintain** to take the backup of the database.

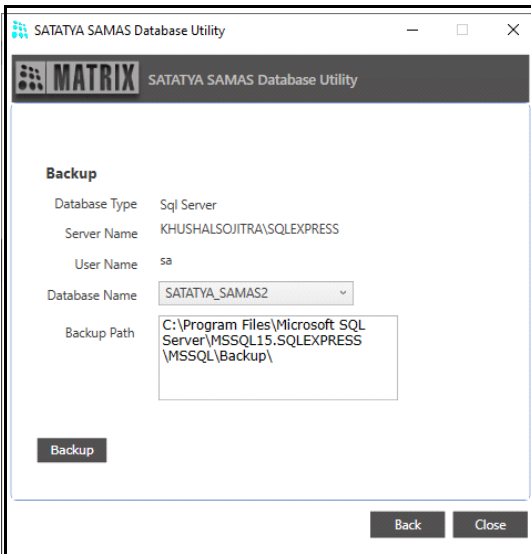

- Select the **Database Name** from the drop-down list.
- In **Backup Path**, the path of the backup file is displayed where the MS SQL has been installed. This path cannot be changed.

- Click **Backup**. The system will start the backup process as shown below.

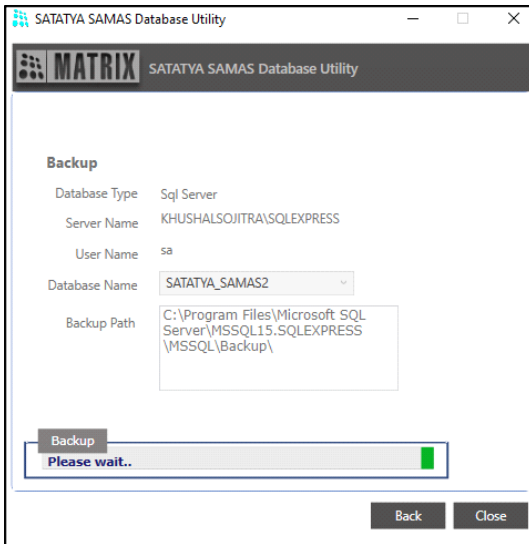

On successful completion of the process, the system displays the path as well as the name of the backup file.

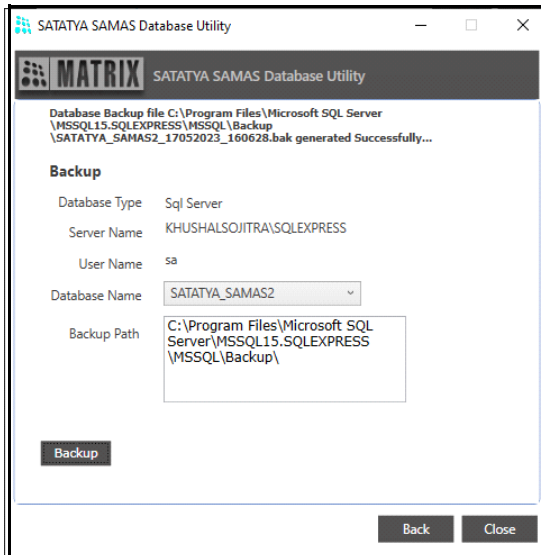

The database backup file is created at the specified location as shown below:

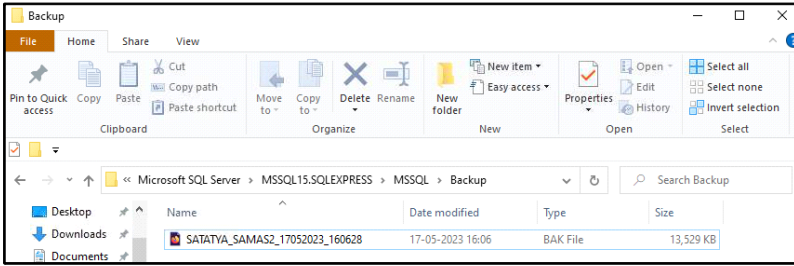

Setting-up the VMSP Server using the Manager Utilities

Once the SAMAS Database installation is successfully completed, the you must perform the following steps before configuring the *Admin Client*.



The Management Server, License Server and Database must be in the same network, in-case of Server Based License Dongle.



Crystal Reports Runtime 13.0 which is required for report generation and must be installed where Management Server is installed. Matrix does not provide this software for installation.

Step 1: Configure License Server Settings using the License Server Manager Utility.

The License Server Settings helps to configure the Listening Port of the installed License Server.

- Ensure that you have license dongle with you and the License Server and Dongle must be on the same PC.
- Click on your PC Search option and enter **License Server Manager**. Click the same.

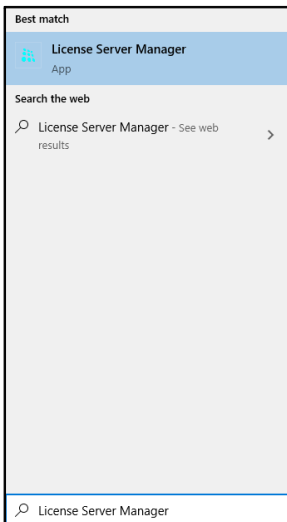

- The License Server icon appears in the Tray. Right-click on the **License Server** icon.

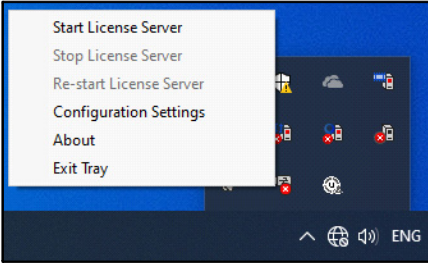

- Select **Configuration Settings**. The **SAMAS Server License Manager** window appears.

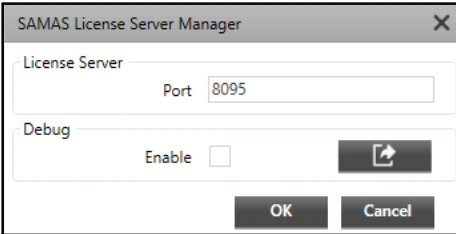

License Server

- Specify the Listening **Port** on which License Server communicates with the Management Server.

Debug

- Select the **Enable** check box to enable the debug. Click **Export Logs**  and specify the path of the local system where you wish to store the logs.
- Click **OK** to save the License Server Settings.

Now from the Tray, right-click on the **License Server** icon again and select **Start License Server** to start the server.

Step 2: Configure Management Server Settings using the Management Server Manager Utility

The Management Server is responsible for centralized authentication, logging (events, actions, user activities, etc.) and configuration of the security system consisting of video surveillance devices.

- Click on your PC Search option and enter **Management Server Manager**. Click the same.

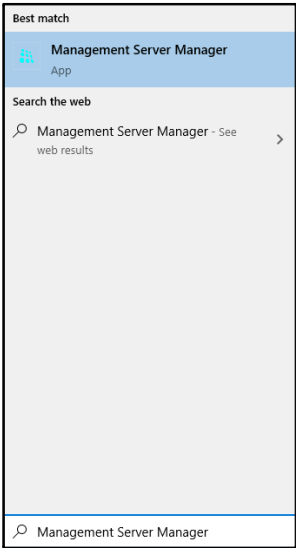

- The Management Server icon appears in the Tray. Right-click on the **Management Server icon**.

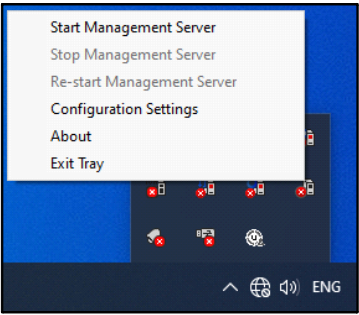

- Select **Configuration Settings**. The **SAMAS Management Server Manager** window appears.

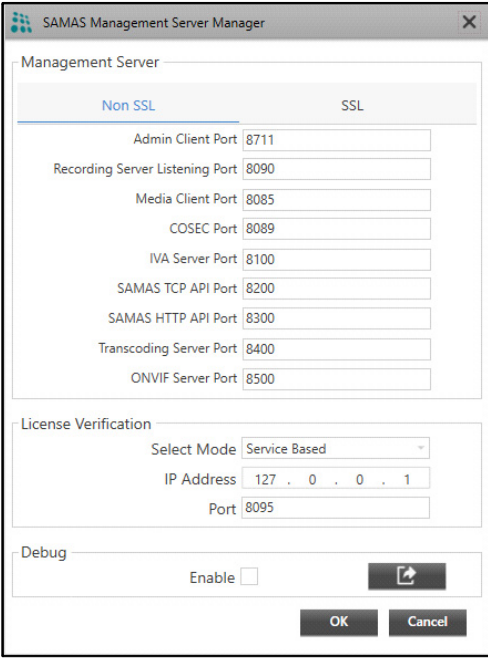

- In the **Management Server Manager** window, enter Port configurations for establishing communication with *Admin Client*, *Recording Server*, *Media Client*, *COSEC Server*, *IVA Server*, *HTTP and TCP Port* and *License Server* with SSL or Non SSL connection as required.

The following communication between Client and Server will be secure.

Client	Server
Media Client (Smart Client, Multi-Monitor Client)	Management Server
IVA Server	Management Server
Media Client (Smart Client, Multi-Monitor Client)	Recording Server
IVA Server	Recording Server

The **Non SSL** connection ports are shown as below:

The screenshot shows the SAMAS Management Server Manager dialog box. It has three main sections: Management Server, License Verification, and Debug. The Management Server section has two tabs: Non SSL (selected) and SSL. Under Non SSL, there are several port configuration fields: Admin Client Port (8711), Recording Server Listening Port (8090), Media Client Port (8085), COSEC Port (8089), IVA Server Port (8100), SAMAS TCP API Port (8200), SAMAS HTTP API Port (8300), Transcoding Server Port (8400), and ONVIF Server Port (8500). The License Verification section has a Select Mode dropdown set to Service Based, an IP Address field set to 127.0.0.1, and a Port field set to 8095. The Debug section has an Enable checkbox which is unchecked and an Export Logs button. At the bottom are OK and Cancel buttons.

Port Name	Value
Admin Client Port	8711
Recording Server Listening Port	8090
Media Client Port	8085
COSEC Port	8089
IVA Server Port	8100
SAMAS TCP API Port	8200
SAMAS HTTP API Port	8300
Transcoding Server Port	8400
ONVIF Server Port	8500

License Verification

Select Mode: Service Based

IP Address: 127 . 0 . 0 . 1

Port: 8095

Debug: Enable Export Logs

OK Cancel

License Verification for Non SSL

License Verification for Non SSL connection can be done with **Service Based** mode where the license dongle is to be connected to the License Server machine.

IP Address: Enter the IP address of the License Server machine where the Licensed Dongle is connected.

Port: Specify the Listening Port on which License Server communicates with the Management server.

Debug

Select the **Enable** check box to enable debug. Click **Export Logs** and specify the path of the local system where you wish to store the logs.

The **SSL** connection port settings is shown as below:

The screenshot shows the SAMAS Management Server Manager dialog box with the SSL tab selected. The 'Enable Secure Connection' checkbox is checked, and an 'Upload' button is visible. Below it are text boxes for various ports: Admin Client Port (7711), Recording Server Listening Port (7090), Media Client Port (7085), COSEC Port (7089), IVA Server Port (7100), SAMAS TCP API Port (7200), SAMAS HTTP API Port (7300), Transcoding Server Port (7400), and ONVIF Server Port (7500). The 'License Verification' section has a 'Select Mode' dropdown set to 'Service Based', an 'IP Address' field with '127.0.0.1', and a 'Port' field with '8095'. The 'Debug' section has an 'Enable' checkbox that is unchecked. At the bottom are 'OK' and 'Cancel' buttons.

- Select the Enable Secure Connection check box and upload the SSL certificate by clicking the Upload  button.

To know more about **SSL** refer to the SATATYA SAMAS Installation Guide.

License Verification for SSL

License Verification for SSL Connection can be done with **Service Based** or **Device Based** mode.

Service Based

Select Service Based mode from the **Select Mode** drop-down list if the license dongle is to be connected with the License Server machine.

- **IP Address:** Enter the IP address of the License Server machine where the Licensed Dongle is connected.
- **Port:** Specify the Listening port on which License Server communicates with the Management server. Make sure the same Port number is entered in the License Server.



By default, Management Server runs on the IP Address of the system where it is installed.

To know more about Device based license refer to the **SATATYA SAMAS Installation Guide**.

Debug

Select the **Enable** check box to enable debug. Click **Export Logs**  and specify the path of the local system where you wish to store the logs.

- Click **OK** to save the settings.

Now again from the windows taskbar, select **Start Management Server** to start the service on the system.

Step 3: Configure Recording Server settings using the Recording Server Manager Utility.

The Recording Server is responsible for communicating with the video surveillance devices, recording the video streams into its storage drive, and streaming live and recorded videos to the clients.

- Click on your PC Search option and enter **Recording Server Manager**. Click the same.

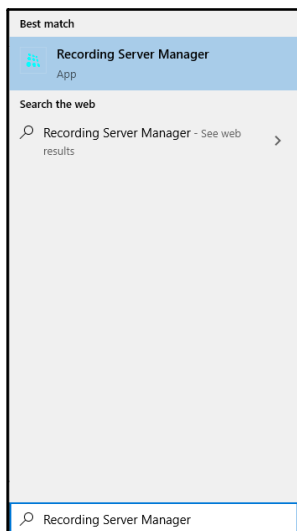

- The Recording Server icon appears in the Tray. Right-click on the **Recording Server** icon.

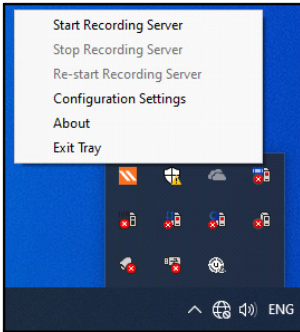

- Click **Configuration Settings** and the following configuration window appears.
- Select **Configuration Settings** and the **SAMAS Recording Server Manager** window appears.

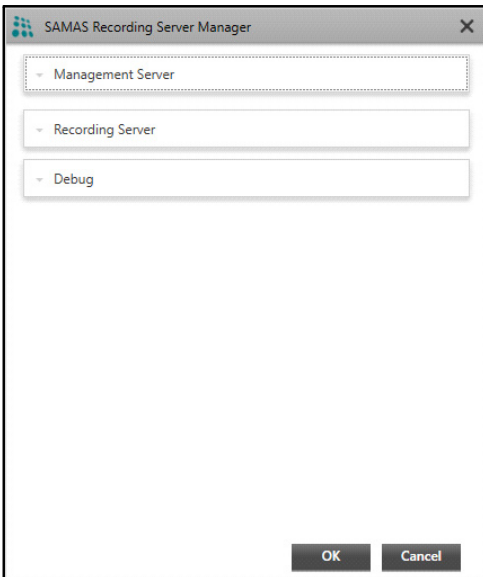

It includes the configuration of Management Server, Recording Server as well as the Debug. For details, click on the respective link.

[“Management Server”](#)

[“Recording Server”](#)

[“Debug”](#)

Management Server

For the Recording Server (RS) to communicate with the Management Server (MS), a connection between them needs to be established by configuring the MS IP Address and Port in the RS-Manager. But it is not necessary that both the components are located in same network (private), they may be located in two different networks (public). Hence, SAMAS allows to configure 3 Preferred Networks where you can add private network as well as public network of MS.

Expand the **Management Server** panel as shown below to configure parameters for Preferred Network 1 (PN1), Preferred Network 2(PN2) and Preferred Network 3 (PN3).



The screenshot shows the SAMAS Recording Server Manager dialog box. The 'Management Server' section is expanded, revealing three 'Preferred Network' sections. Each section contains two input fields: 'IP or Server Name' and 'Port'. The first section (Preferred Network 1) has '127.0.0.1' in the IP field and '8090' in the Port field. The other two sections (Preferred Network 2 and Preferred Network 3) have empty input fields. Below these sections are 'Recording Server' and 'Debug' sections, also with empty input fields. At the bottom of the dialog are 'OK' and 'Cancel' buttons.

- **IP Address or Server Name:** Enter either the Private or Public IP address of Management Server or enter Host Name, Domain Name or Server Name of ISP1 and ISP2.
- **Port:** Enter either Private or Public Port.

Recording Server

Live Stream of the cameras can be accessed using clients such as Admin Client, Smart Client and IVA Server. For this, clients has to communicate with the Recording Server (RS).

Also, it is not necessary that both client and RS are located in the same network, they may be located in two different networks. So to serve both the scenarios, SAMAS allows to configure preferred networks, where user can add private as well as public networks of RS.

Expand the **Recording Server** panel as shown below to configure the following parameters.

The screenshot shows the SAMAS Recording Server Manager window. The 'Recording Server' section is expanded, revealing the following configuration options:

- SSL Port:** 7050
- Auto Add Device Port:** 8151
- Preferred Network 1:**
 - Auto Detect IP Address
 - IP or Server Name: 192.168.103.99
 - Port: 8050
- Preferred Network 2:**
 - IP or Server Name: [Empty]
 - Port: [Empty]

The 'Debug' section is collapsed. The 'OK' and 'Cancel' buttons are located at the bottom right of the dialog.

- **SSL Port:** Specify the **SSL Port** where secure connection with RS will be established.
- **Auto Add Device Port:** Specify the **Auto Add Device Port** to communicate with SATATYA Devices like VMSP Server and automatically add the devices into SAMAS.

Recording Server (RS) will listen to Auto Addition Device request on this port.

- **Auto-Detect IP Address:** If the **Auto-Detect IP Address** check box is enabled then IP Address of your PC where Recording Server is installed is considered as IP Address of Recording Server. Whenever the IP Address of the PC is changed then the same is updated as Recording Server IP.

If Auto-Detect IP Address is disabled then you need to specify the **IP Address** and **Port** of Recording server.

Enter the following parameters of Recording Server in **Preferred Network 1,2 and 3**.

- **IP Address or Server Name:** Enter either Private or Public IP address of Recording Server. In this field, you can also enter Host Name, Domain Name or Server Name of ISP1 and ISP2.
- **Port:** Enter either Private or Public Port on which RS listens client request.

For Private Network, enter the 'Recording Server Port'.

For Public network, enter the forwarded port (ISP1 Port/ISP2 Port) that has been mapped with the internal 'Recording Server Port'.

- Click **OK** to save settings.

Debug

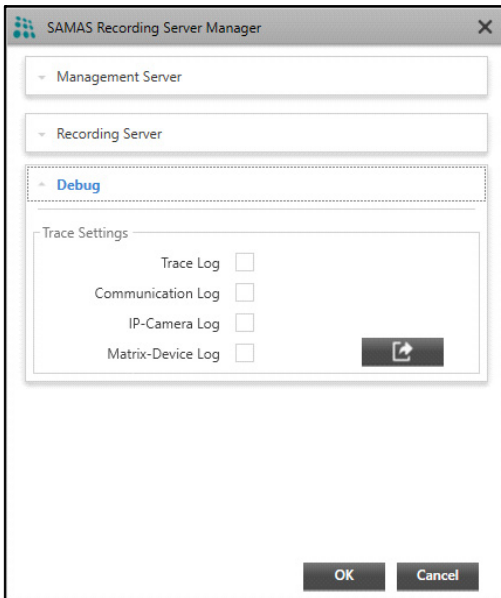

- Select the check boxes of the desired options for which you wish to enable debug. Click **Export Logs**  and specify the path of the local system where you wish to store the logs.
- Now again from the windows taskbar, select **Start Recording Server** to start the service on the system.
- The Recording Server will show Activation Pending till the server is not activated. The Servers are activated from the Admin Client. Refer "[Accessing the Admin Client](#)".
- After activating, the Recording Server will start.

Step 4: Configure Notification Server settings using the Notification Server Manager Utility.

The E-mail and SMS Notification Server is responsible for configuration of Mail Server and SMS Service provider to send E-mail and SMS notifications to the User.

- Click on your PC Search option and enter **Notification Server Manager**. Click the same.

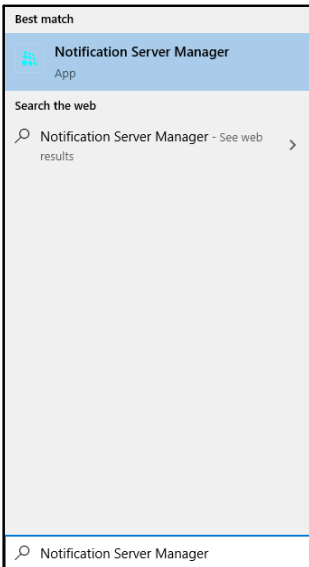

- The Notification Server icon appears in the Tray. Right-click on the **Notification Server** icon.

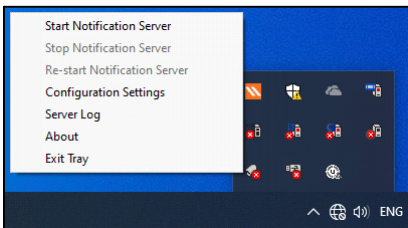

- Select **Configuration Settings**. The **SAMAS Notification Server Manager** window appears.

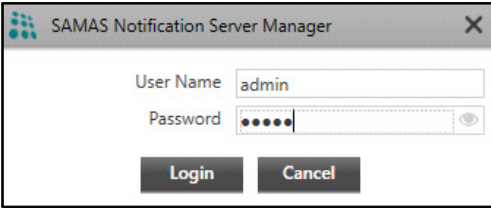

- Enter the **User Name** and **Password** as configured in Admin Client. Refer [“Accessing the Admin Client”](#).
- Click **Login**.

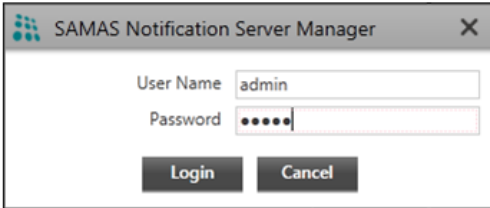

Make sure the user has the configuration rights of E-mail and SMS Settings in System Accounts of Admin Client.

The Notification Server Manager window appears as shown below:

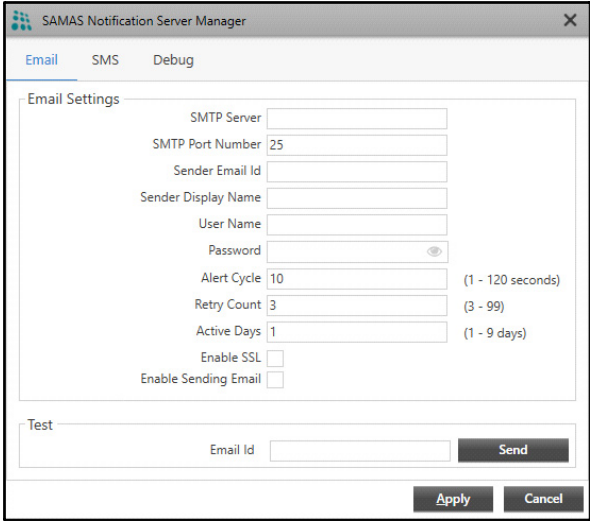

E-mail Settings

For the E-mail Settings, configure the following parameters.

SMTP Server: Specify the IP Address or Name of the configured SMTP Server.

SMTP Port Number: Specify the TCP port for the SMTP service as set in the SMTP Server.

Sender E-mail ID: Enter the sender's E-mail ID.

Sender Display Name: Enter the User Name that will be displayed in the E-mails.

User Name: Specify the User Name as set in the E-mail account.

Password: Specify the Password as set in the E-mail account.

Alert Cycle: Specify the time in seconds between successive send attempts when the system tries to send the pending messages.

Retry Count: Specify the number of times the system needs to retry to send the same E-mail message in the event of an unsuccessful attempt.

Active Days: Specify the number of days the system needs to keep the unsent messages active in the event of the service being stopped.

Enable SSL: In the event of using an external SMTP Server like Gmail, then make sure this is enabled.

Enable Sending E-mail: Select this check box to enable the mail sending functionality.

E-mail Id: Enter the E-mail ID to check the connectivity and click **Send**.

Click **Apply** to save the settings.

Now again from the windows taskbar, select **Start Notification Server** to start the service on the system.

SMS Settings

For the SMS settings, select **Custom** as the Service Provider.

Custom Service Provider Settings

You can add a Service Provider other than the ones provided by default. To do so,

- Select **Custom** as the Service Provider option. Maximum 99 service providers can be added.
- Click **Add** + .

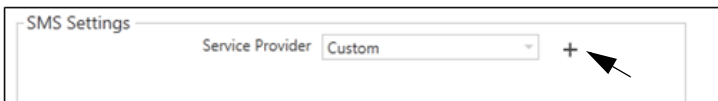

Specify the API configuration parameters for the new Service Provider:

Request

Service Provider Name: This is the Service Provider's Name.

Service Provider URL: This is the Service Provider's Website used for registration etc.
E.g. www.msgatewaycentre.com.

Base URL: This is the URL to which arguments such as user name, password etc. are to be appended. E.g. http://msgatewaycentre.com/library/send_sms_2.php

API Argument: Enter the argument required to be mentioned while constructing the URL. E.g. "User", "Password" etc.

Argument Value: Select a value to be mapped against the defined API Argument. Select "Custom" to define a custom static value.

Click **Add Argument** to save the new argument and value.

Custom Service Provider

Request

Service Provider Name: SMS Lane

Service Provider URL: www.smslane.com

Base URL: http://world.smslane.com/vendorsms/Glob

API Argument:

Argument Value: User Name

Custom:

Add Argument Cancel

API Argument	Argument Value	Delete
User	User Name	🗑️
Password	Password	🗑️

Argument Separator: ;

Request Method: POST

Request Preview: http://world.smslane.com/vendorsms/GlobalPush.aspx??

Balance

Balance Check:

Balance URL:

Apply Cancel

Response

API Response: Error 404

SAMAS Response: Failure

Add Response Cancel

Argument Separator: Define a character that can be used as a valid separator between arguments used to construct the API URL. E.g. “&”.

Request Method: Select a method by which the request is to be sent.

Request Preview: Displays the preview of the updated API request.

Balance

Balance Check: Select this check box if you want the Balance URL to be displayed.

Balance URL: Displays the URL, which can be edited, if required.

Response

API Response: Define the response or error codes. Maximum 99 responses can be configured.

SAMAS Response: For the configured API response, select the corresponding SAMAS Response. Such as Success or Failure. E.g. Error 404 should be considered as Failure.

Click **Add Response** to save the response configuration.

Debug

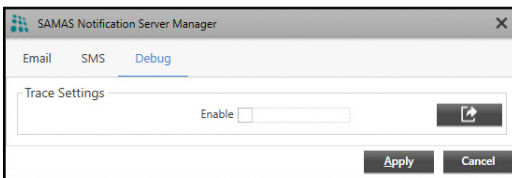

Select the **Enable** check box to enable debug. Click **Export Logs**  and specify the path of the local system where you wish to store the logs.

Click **Apply** to save the changes.

Now from the Tray, right-click on the **Notification Server** icon again and select **Start Notification Server** to start the service.

Communication of Management Server (MS), Recording Server (RS) and License Server (LS)

If the License Server is located at the Head Office - 192.168.104.20, Management Server is at the Branch Office - 192.168.104.17 and Recording Server with cameras is located at the Server Room - 192.168.104.23

To view cameras in the Server Room from Branch Office, specify the License Server Port (where SAMAS Dongle is connected) in the License Server Manager of Branch Office PC.

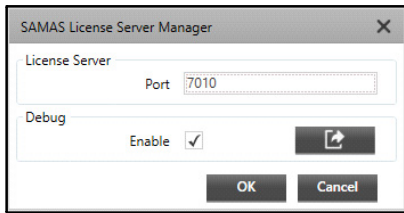

In the Management Server Manager enter the License Server IP 192.168.104.20 and Port 7010.

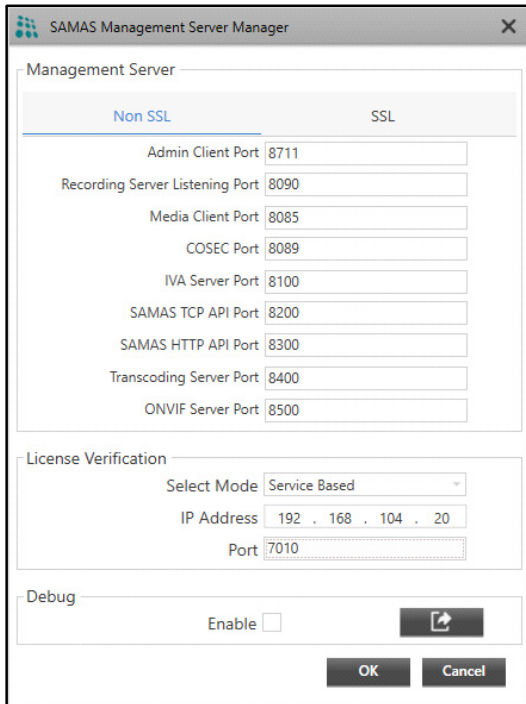

Now the Recording Server is installed at 192.168.104.23. So open the Recording Server Manager and enter the IP Address as 192.168.104.17 and port as 8090 of MS.

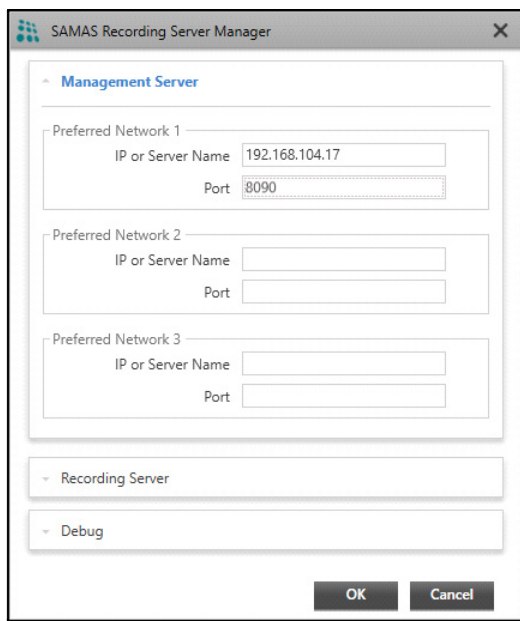

The RS will send request to MS to activate. From the Admin Client the RS has to be activated and then cameras of the RS can be viewed in the Smart Client.

 *For the Version details about each Server, right-click on the particular Server icon on the Windows taskbar and click **About** as shown below.*

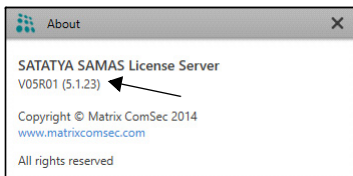

To configure the IVA Server, refer to the **SATATYA SAMAS Installation Guide**.

Configuring the VMSP Server

Accessing the Admin Client

Follow the step-by-step installation procedure as instructed in the Installation Guide. On

completion of installation, the *Admin Client* shortcut icon  appears on your Windows desktop.



Make sure you have provided full access rights (manually) to the SATATYA SAMAS Admin Client Folder you installed.

Double-click on this icon to launch the *Admin Client* application. The login page appears as shown below.

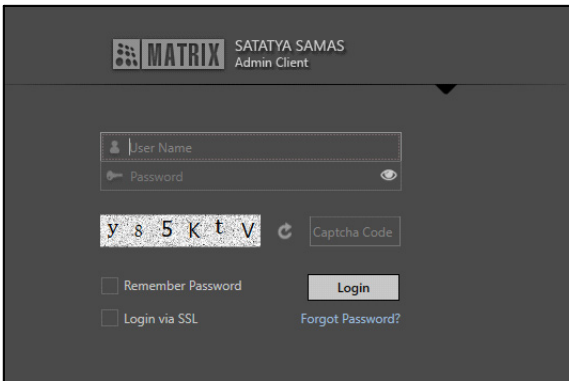



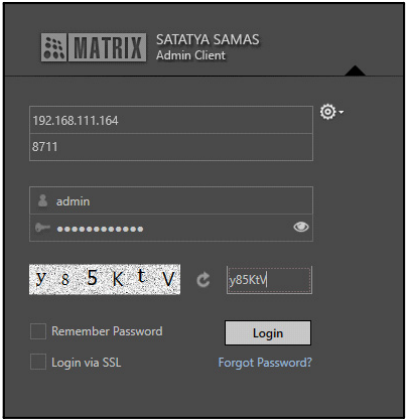
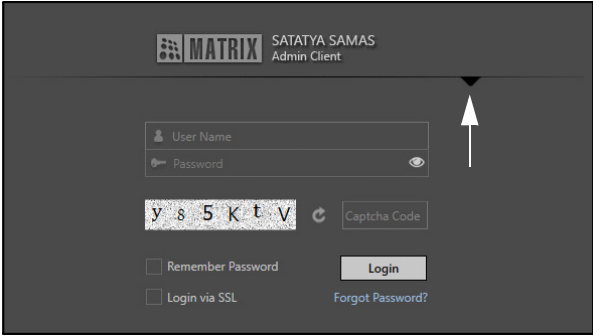

To access the Admin Client, make sure the Management Server is installed and configured, so that the connection between the Admin Client and Management Server (MS) can be established.

Follow the steps below:

- Click  to expand the panel. Enter the IP Address and Port.



- **IP Address or Server Name:** Enter either Private or Public IP address of Management Server. You can also enter the Host Name, Domain Name or Server Name of ISP1 and ISP2.
- **Port:** Enter either Private or Public Port.
- The first login can be performed using the default User Name “**admin**”.
- Enter the Captcha code. The Captcha code helps in increasing security of application by differentiating between real and automated users. Click **Refresh**  to refresh the Captcha code.
- Click **Login**.

- At the time of first login, you will be prompted to set a new password. The SAMAS stores a list of frequently used passwords in a database and compares the new password with the same. SAMAS will not allow you to configure such frequently used passwords to enhance security.
- To create a strong password make sure you enter one special character, one number, one lowercase and one uppercase character. The Password Meter displays the strength of the password you enter. Make sure you enter 12 characters (default value) as the password length. For details, refer to SATATYA SAMAS Admin Client Manual, General Settings > System Settings > Password Settings.
- Click **Show**  to view the password. The icon toggles to **Hide** . Click **Hide**  to hide the password.

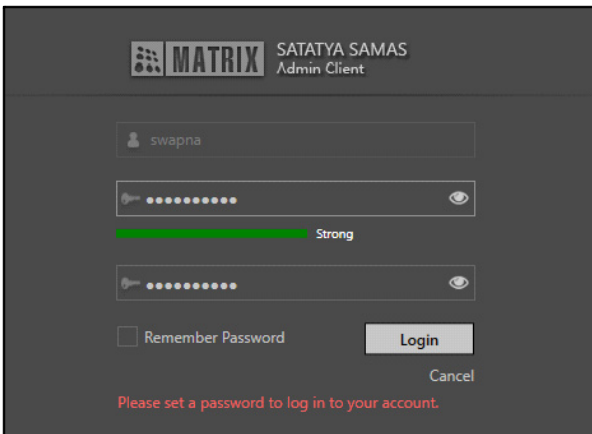

Thus, the user can now use the new credentials to login into the Admin Client.



At the time of first login, you will be prompted to set a new password. Create a strong password and make sure you note it down in a secure place for future reference.

End User License Agreement

MATRIX - END USER LICENSE AGREEMENT

IMPORTANT – READ THIS AGREEMENT BEFORE USING MATRIX SOFTWARE AND SOFTWARE PRODUCTS INTENDED TO BE USED WITH THE MATRIX DEVICES. BY DOWNLOADING, INSTALLING, COPYING OR USING ALL OR ANY PORTION OF MATRIX'S SOFTWARE, YOU AGREE TO BE BOUND BY TERMS OF THIS EULA. IF YOU DO NOT AGREE WITH THIS EULA, PLEASE DO NOT INSTALL OR USE THE SOFTWARE AND SOFTWARE PRODUCTS INTENDED TO BE USED WITH THE MATRIX DEVICE.

This End User License Agreement ("EULA") is a legal agreement between you (The term "you" shall include the following but not limited to USERS, END USERS, AUTHORIZED USERS, CUSTOMERS, BUYERS, INDIVIDUALS OR GROUP OF PEOPLE, ORGANISATION purchasing, renting, leasing, selling, using and dealing with the products and software manufactured by MATRIX) and MATRIX COMSEC PRIVATE LIMITED (hereinafter referred to as "MATRIX"), for the Software whether pre-installed or downloaded, owned by MATRIX which includes computer software and may include associated media, content and data, printed materials, or electronic documentation in connection with your use of Matrix Software and device.

The Software includes the software(s) which are downloaded from FTP, but not limited to the software(s) embodied in MATRIX Products, including updates or modified software provided to you by MATRIX, whether stored on device, media (CD or DVD) or downloaded via any method, but not Excluded Software as defined below.

MATRIX may add to, change, or remove any part, term, or condition of this EULA, including but not limited to as it applies to the Products and Software at any time without prior notice or liability to you. Any such additions, changes, or removals posted at <https://www.matrixcomsec.com/> shall apply as soon as they are posted. By continuing to use the Software and Product after so posted, you are indicating your acceptance thereto.

1. SOFTWARE LICENSE & RESTRICTIONS

The Software (including, but not limited to, any images, photographs, video, audio, text and numbers incorporated into the Software) is owned by MATRIX, and its structure, organization and code are valuable trade secrets of MATRIX. Except as expressly set forth in this EULA, this EULA does not grant you any intellectual property rights in the Software and Products, and you cannot use the Software except as specified herein. The Software is licensed, not sold. If you received a trial version of the Software, subject to your compliance with the terms and conditions of this EULA, MATRIX grants you a limited license for a limited trial period to use one (1) copy of the Software to evaluate the Software, and only for your personal, non-commercial use on a single computer or mobile device, as applicable. Matrix Products and software cannot be used as a general purpose computer expect and otherwise, its intended use. The Software may create data files automatically for use with the Software, and you agree that any such data files are deemed to be a part of the Software. This does not include, however, any user-generated content or project files, which will remain the property of the owner. The Software is licensed as a single product, and you may not separate its component parts for use on more than one (1) computer or mobile device unless expressly authorized by MATRIX. You agree not to copy, modify, publish, adapt, redistribute, reverse engineer, decompile, disassemble, attempt to derive or discover source code, or otherwise reduce to a human-perceivable form, or create derivative works of, the Software in whole or in part, or to use the Software in whole or in part for any purpose other than as expressly permitted under this EULA. You may not modify or tamper with any digital rights management functionality of the Software and product, or bypass, modify, defeat or circumvent any of the functions or protections of the Software and product or any mechanisms operatively linked to the Software and product. In addition, you may not share, distribute, loan, rent, lease, sublicense, assign, transfer, or sell the Software, but you may transfer all of your rights under this EULA only as part of a sale or transfer of the Product provided: (i) you retain no copies of, and transfer all of the Software (including but not limited to all copies, component parts, any media, printed materials, all versions and any upgrades of the Software, and this EULA) as part of such sale or transfer; (ii) uninstall the Software from any device where it has been installed; and (iii) the recipient agrees to the terms of this EULA and MATRIX's privacy policy. MATRIX expressly reserves and

I accept the terms and conditions of End User License Agreement.

Submit

Select the **I accept the terms and conditions of End User License Agreement (EULA)** check box and click **Submit**.

The **SATATYA SAMAS Admin Client** Homepage appears as shown below:

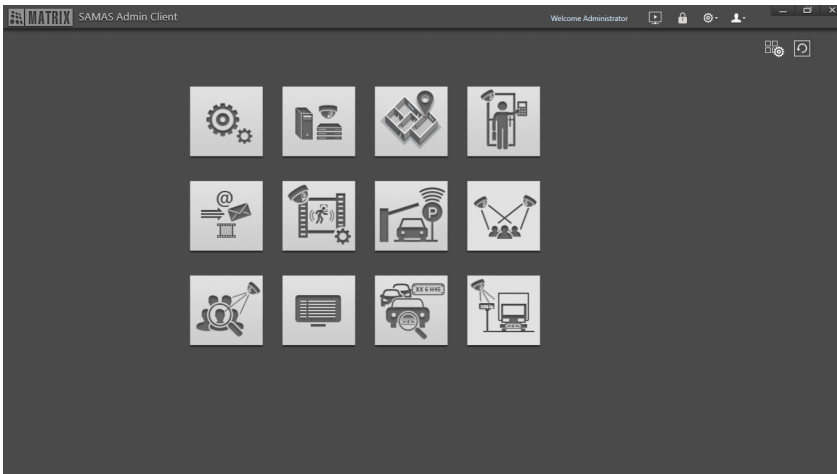

For configuring, refer to the **SATATYA SAMAS Administrator Guide**.

Accessing the Smart Client

Follow the step-by-step installation procedure as instructed in the Installation Guide. On

completion of installation, the *Smart Client* shortcut icon



appears on your Windows

desktop.



Make sure you have provided full access rights (manually) to the SATATYA SAMAS Smart Client Folder you installed.

Double-click on this icon to launch the *Smart Client* application.

The Smart Client login page appears:

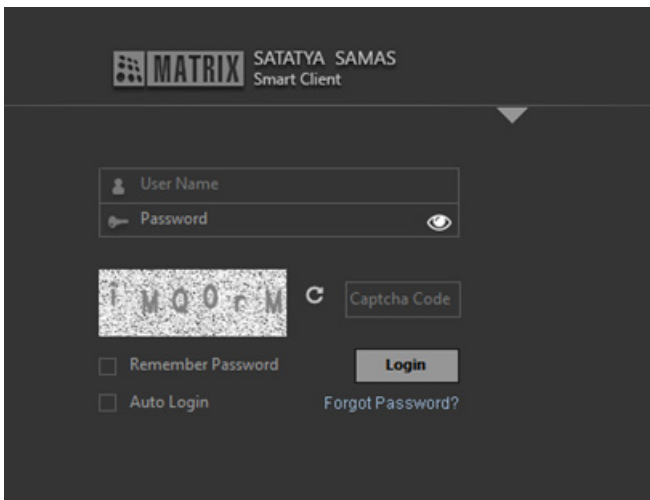
The screenshot shows a dark-themed login interface. At the top left, there is a 'MATRIX' logo and the text 'SATATYA SAMAS Smart Client'. Below this, there are two input fields: 'User Name' and 'Password'. The 'Password' field has an eye icon to toggle visibility. To the right of the password field is a 'Captcha Code' field with a refresh icon. Below the input fields are two checkboxes: 'Remember Password' and 'Auto Login'. A 'Login' button is positioned to the right of the checkboxes. At the bottom right, there is a link for 'Forgot Password?'. The background of the login area is dark with a subtle grid pattern.

*Customized logo will be shown on the login page, Set Password and Forgot Password page instead of **MATRIX** logo, if it is configured in SAMAS Admin Client. Refer SATATYA SAMAS Administrator Guide for the configuration of custom logo, in General Settings > System Settings > Logo Personalization.*

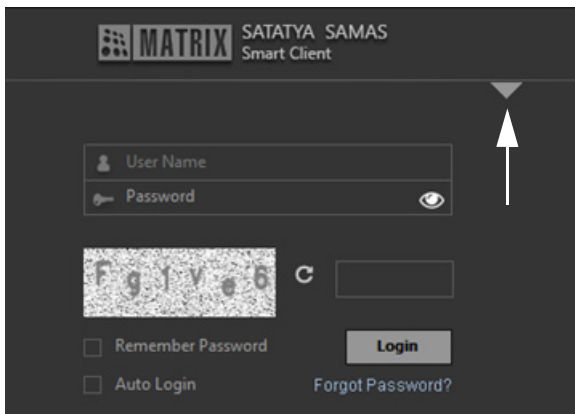

Follow the steps given below to configure the network parameters.

Click  to expand the panel. Enter the IP Address and Port.



- **IP Address or Server Name:** Enter either Private or Public IP address of Management Server. In this field, you can also enter Host-name, Domain name or server name of ISP1 and ISP2.
- **Port:** Enter either Private or Public Port.
- The first login can be performed using the default User Name “**admin**”.
- Enter the **Captcha code**. The Captcha code helps in increasing security of application by differentiating between real and automated users. Click Refresh to refresh the Captcha code.
- Click **Login**.
- At the time of first login, you will be prompted to set a new password. The SAMAS stores a list of frequently used passwords in a database and compares the new password with the

same. SAMAS will not allow you to configure such frequently used passwords to enhance security.

- To create a strong password make sure you enter one special character, one number, one lowercase and one uppercase character. The Password Meter displays the strength of the password you enter. Make sure you enter 12 characters (default value) as the password length. Make sure you note down the created password at a secure place for future reference. For details, refer to SATATYA SAMAS Admin Client Manual, General Settings > System Settings > Password Settings.
- Click **Show**  to view the password. The icon toggles to **Hide** . Click **Hide**  to hide the password.

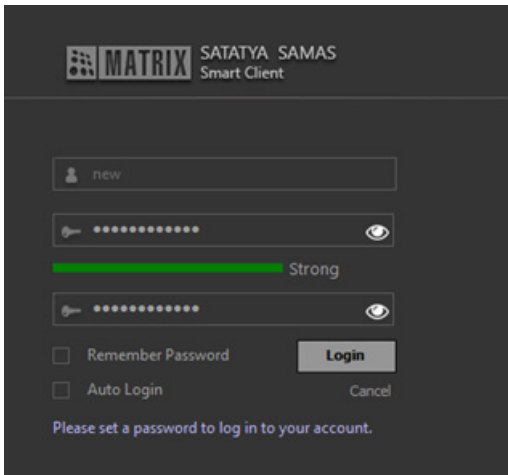

- Click **Login**. The Smart Client Home page appears.

Thus, the user can now use the new credentials to login into the Smart Client.

The Smart Client home page appears.

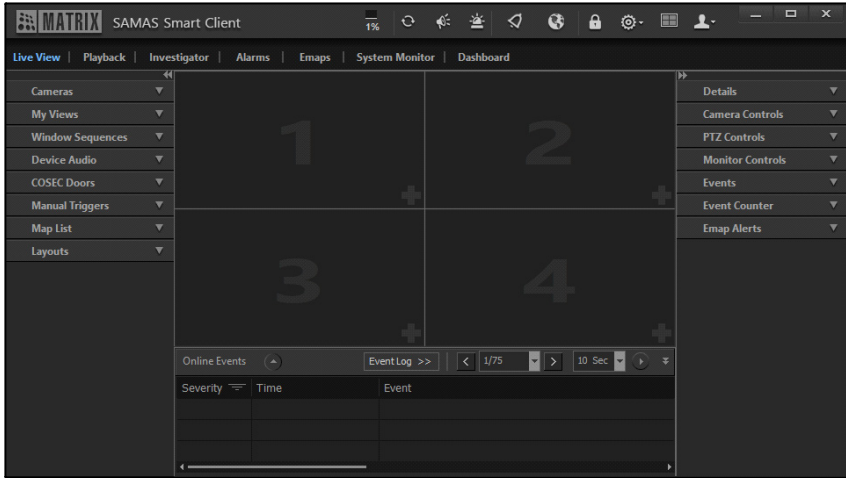

*Customized logo will be shown on the Title Bar of each tabs instead of **MATRIX** logo if it is configured in SAMAS Admin Client. Refer SATATYA SAMAS Administrator Manual for the configuration of custom logo, in General Settings > System Settings > Logo Personalization.*

For detailed configurations, refer to the **SATATYA SAMAS Smart Client Manual**.

Accessing the Multi Display Client (from separate workstation system)

The Matrix Multi Display Client¹ provides the user with an interface to view live stream of cameras on Multiple Displays configured on a single System. The single CPU can connect to multiple Displays through a graphic card.

Sometimes it is desirable to view various Camera Stream on different Displays to get a large Desktop Space in a single System. The Multi Display Client serves this purpose. The user can view the live stream through the created views.

For details, refer to the **SATATYA SAMAS Multi Display Manual**.

1. *In the future releases, the Multi Display Client will be merged with the Smart Client.*

Accessing the Media Player (from separate workstation system)

The Matrix SAMAS Media Player provides the user with an interface to view the records stored in Backup Storage. With the Media Player, user can scan the video records, perform basic playback functions viz. 'Play', 'Pause', 'Stop', 'Smooth Reverse Play', 'Speed-up', 'Speed-down', 'Previous frame' and 'Next frame'.

It is also sometimes desirable to play recorded videos from selected cameras in a synchronous manner i.e. all videos being played synchronously with reference to a single time instance. This feature shall also be supported in the Media Player. Also the IVA operations can be performed with the SAMAS Media player.

For details, refer to the ***SATATYA SAMAS Media Player Manual***.

Appendix

Disposal of Products/Components after End-Of-Life

Main components of Matrix products are given below:

- **Soldered Boards:** At the end-of-life of the product, the soldered boards must be disposed through e-waste recyclers. If there is any legal obligation for disposal, you must check with the local authorities to locate approved e-waste recyclers in your area. It is recommended not to dispose-off soldered boards along with other waste or municipal solid waste.
- **Batteries:** At the end-of-life of the product, batteries must be disposed through battery recyclers. If there is any legal obligation for disposal, you may check with local authorities to locate approved batteries recyclers in your area. It is recommended not to dispose off batteries along with other waste or municipal solid waste.
- **Metal Components:** At the end-of-life of the product, Metal Components like Aluminum or MS enclosures and copper cables may be retained for some other suitable use or it may be given away as scrap to metal industries.
- **Plastic Components:** At the end-of-life of the product, plastic components must be disposed through plastic recyclers. If there is any legal obligation for disposal, you may check with local authorities to locate approved plastic recyclers in your area.

After end-of-life of the Matrix products, if you are unable to dispose-off the products or unable to locate e-waste recyclers, you may return the products to Matrix Return Material Authorization (RMA) department.

Make sure these are returned with:

- proper documentation and RMA number
- proper packing
- pre-payment of the freight and logistic costs.

Such products will be disposed-off by Matrix.

"SAVE ENVIRONMENT SAVE EARTH"



MATRIX COMSEC Pvt. Ltd.

Head Office:

394-GIDC, Makarpura, Vadodara - 390010, India.

Ph: (+91)1800-258-7747

E-mail: Tech.Support@MatrixComSec.com

www.matrixcomsec.com